



**Triton 9600 ATM  
User Manual**

**For Sales & Service  
Call 888-501-5246**

**Email:  
sales@atmdepot.com**

**Compl i ments of: [www.atmdepot.com](http://www.atmdepot.com)**

**For Sales & Service Call: 888-501-5246**

---

## FCC COMPLIANCE

### **Warning:**

Changes or modifications to this unit not expressly approved by the party responsible for compliance could void the user's authority to operate the equipment.

### **Note:**

This equipment has been tested and found to comply with the limits for a Class A digital device, pursuant to Part 15 of FCC Rules. These limits are designed to provide reasonable protection against harmful interference when the equipment is operated in a commercial environment. This equipment generates, uses, and can radiate radio frequency energy and, if not installed and used in accordance with the instruction manual, may cause harmful interference to radio communications. Operation of this equipment in a residential area is likely to cause harmful interference in which case the user will be required to correct the interference at his own expense.

## CANADIAN EMISSION REQUIREMENTS

This digital apparatus does not exceed the Class A limits for radio noise emissions from digital apparatus set in the Radio Interference Regulations of the Canadian Department of Communications.

Le present appareil numerique n'emet pas de bruits radioelectriques depassant les limites applicables aux appareils numeriques de la Class A prescrites dans le Reglement sur le brouillage radioelectrique edicte par le ministere des Communications du Canada.

## AUSTRALIAN EMISSION REQUIREMENTS

### **Warning:**

This is a Class A product. In a domestic environment this product may cause radio interference in which case the user may be required to take adequate measures.

Compliments of: [www.atmdepot.com](http://www.atmdepot.com)

---

**NOTICE:**

The Industry Canada label identifies certified equipment. This certification means that the equipment meets telecommunications network protective, operational and safety requirements as prescribed in the appropriate Terminal Equipment Technical Requirements document(s). The Department does not guarantee the equipment will operate to the user's satisfaction.

Before installing this equipment, users should ensure that it is permissible to be connected to the facilities of the local telecommunications company. The equipment must also be installed using an acceptable method of connection. The customer should be aware that compliance with the above conditions may not prevent degradation of service in some situations.

Repairs to certified equipment should be coordinated by a representative designated by the supplier. Any repairs or alterations made by the user to this equipment, or equipment malfunctions, may give the telecommunications company cause to request the user to disconnect the equipment.

Users should ensure for their own protection that the electrical ground connections of the power utility, telephone lines and internal metallic water pipe system, if present, are connected together. This precaution may be particularly important in rural areas. Caution: Users should not attempt to make such connections themselves, but should contact the appropriate electric inspection authority, or electrician, as appropriate.

**NOTICE:**

The Ringer Equivalence Number (REN) assigned to each terminal device provides an indication of the maximum number of terminals allowed to be connected to a telephone interface. The termination on an interface may consist of any combination of devices subject only to the requirement that the sum of the Ringer Equivalence Numbers of all the devices does not exceed 5.

---

**AVIS:**

L'étiquette d'Industrie Canada identifie le matériel homologué. Cette étiquette certifie que le matériel est conforme aux normes de protection, d'exploitation et de sécurité des réseaux de télécommunications, comme le prescrivent les documents concernant les exigences techniques relatives au matériel terminal. Le Ministère n'assure toutefois pas que le matériel fonctionnera à la satisfaction de l'utilisateur.

Avant d'installer ce matériel, l'utilisateur doit s'assurer qu'il est permis de le raccorder aux installations de l'entreprise locale de télécommunication. Le matériel doit également être installé en suivant une méthode acceptée de raccordement. L'abonné ne doit pas oublier qu'il est possible que la conformité aux conditions énoncées ci-dessus n'empêche pas la dégradation du service dans certaines situations.

Les réparations de matériel homologué doivent être coordonnées par un représentant désigné par le fournisseur. L'entreprise de télécommunications peut demander à l'utilisateur de débrancher un appareil à la suite de réparations ou de modifications effectuées par l'utilisateur ou à cause de mauvais fonctionnement.

Pour sa propre protection, l'utilisateur doit s'assurer que tous les fils de mise à la terre de la source d'énergie électrique, des lignes téléphoniques et des canalisations d'eau métalliques, s'il y en a, sont raccordés ensemble. Cette précaution est particulièrement importante dans les régions rurales. Avertissement: L'utilisateur ne doit pas tenter de faire ces raccordements lui-même; il doit avoir recours à un service d'inspection des installations électriques, ou à un électricien, selon le cas.

**AVIS:**

L'indice d'équivalence de la sonnerie (IES) assigné à chaque dispositif terminal indique le nombre maximal de terminaux qui peuvent être raccordés à une interface. La terminaison d'une interface téléphonique peut consister en une combinaison de quelques dispositifs, à la seule condition que la somme d'indices d'équivalence de la sonnerie de tous les dispositifs n'exède pas 5.

# CONTENTS

---

<b>SECTION 1 - INTRODUCTION .....</b>	<b>1-1</b>
WHAT'S NEW IN ATM SOFTWARE RELEASE 4.1 .....	1-2
EPROM UPGRADE REQUIREMENT .....	1-2
WHAT'S IN THIS MANUAL .....	1-3
WHAT IS A CASH DISPENSER? .....	1-3
BALANCING DAILY TRANSACTIONS .....	1-4
 <b>SECTION 2 - FEATURES .....</b>	 <b>2-1</b>
SINGLE-CASSETTE CASH DISPENSERS .....	2-2
NEW FEATURES .....	2-2
STANDARD FEATURES OF THE SINGLE-CASSETTE CASH DISPENSERS .....	2-5
 <b>SECTION 3 - OPERATION AND SETUP .....</b>	 <b>3-1</b>
BASIC OPERATION .....	3-2
MENU-BASED OPERATION .....	3-2
KEYPAD OPERATION .....	3-3
CHANGING TO MANAGEMENT FUNCTIONS .....	3-5
INITIAL CASH DISPENSER CONFIGURATION .....	3-6
ADDITIONAL PARAMETERS .....	3-8
SETUP PARAMETERS LISTING .....	3-10
 <b>SECTION 4 - HANDLING CASSETTES .....</b>	 <b>4-1</b>
MEDIA CONDITION .....	4-2
USED CURRENCY .....	4-2
NEW OR UNCIRCULATED CURRENCY .....	4-2
REPLENISHING CASSETTES .....	4-3
 <b>SECTION 5 - MANAGEMENT FUNCTIONS .....</b>	 <b>5-1</b>
INTRODUCTION .....	5-2
ACCESSING THE MANAGEMENT FUNCTIONS MENU .....	5-2
FUNCTION AVAILABILITY .....	5-3
MANAGEMENT FUNCTIONS CHART .....	5-4
FUNCTION: MANAGEMENT FUNCTIONS .....	5-5
FUNCTION: CLOSE .....	5-6
FUNCTION: SCHEDULE CLOSE .....	5-7
FUNCTION: CHANGE SCHEDULE .....	5-8
FUNCTION: TRIAL CASSETTE BALANCE .....	5-9
FUNCTION: TRIAL CLOSE .....	5-10
FUNCTION: DAY CLOSE .....	5-11
FUNCTION: SEND TERMINAL TOTALS .....	5-12
FUNCTION: ENTER QTY. IN CASSETTE .....	5-13
FUNCTION: CASSETTE CLOSE .....	5-14
FUNCTION: DIAGNOSTICS .....	5-15
FUNCTION: STATUS .....	5-16
FUNCTION: PURGE .....	5-17
FUNCTION: TEST DISPENSE .....	5-18
FUNCTION: FORMAT MEMORY EXPANSION CARD .....	5-19
FUNCTION: TEST RECEIPT PRINTER .....	5-20
FUNCTION: VERSION #'S .....	5-21

---

Compliments of: [www.atmdepot.com](http://www.atmdepot.com)

# CONTENTS

---

FUNCTION: MORE DIAGNOSTICS .....	5-22
FUNCTION: RESET/TEST MODEM .....	5-23
FUNCTION: SCAN CARD .....	5-24
FUNCTION: LANGUAGE/IDIOMA .....	5-25
FUNCTION: ENGLISH/INGLES .....	5-26
FUNCTION: SPANISH/ESPAÑOL .....	5-27
FUNCTION: ENABLE/DISABLE CUST. OPTION .....	5-28
FUNCTION: JOURNAL .....	5-29
FUNCTION: PRINT JOURNAL .....	5-30
FUNCTION: CLEAR JOURNAL .....	5-31
FUNCTION: PRINT LAST X ENTRIES .....	5-32
FUNCTION: PASSWORD MAINTENANCE .....	5-33
FUNCTION: MASTER PASSWORD .....	5-34
FUNCTION: ADMINISTRATION PASSWORD .....	5-35
FUNCTION: TERMINAL CONFIGURATION .....	5-36
FUNCTION: PRINTER SETTINGS .....	5-37
FUNCTION: SET PRINT LENGTH .....	5-38
FUNCTION: LOW RECEIPT PAPER .....	5-39
FUNCTION: PRINTER GRAPHICS .....	5-40
FUNCTION: RANDOM/LEVEL PRIZE COUPONS .....	5-41
FUNCTION: ENTER PRIZE LEVEL MSG. ....	5-42
FUNCTION: ENTER RANDOM PRIZE MSG. ....	5-43
FUNCTION: ENABLE/DISABLE COUPON AWARDS .....	5-44
FUNCTION: SET LEVEL PRIZE AMOUNT .....	5-45
FUNCTION: SET RANDOM WINNING % .....	5-46
FUNCTION: CHANGE MESSAGES .....	5-47
FUNCTION: MARKETING MESSAGE .....	5-48
FUNCTION: SURCHARGE MESSAGES .....	5-49
FUNCTION: WELCOME MESSAGE .....	5-51
FUNCTION: SURCHARGE OWNER .....	5-52
FUNCTION: CHANGE EXIT MESSAGE .....	5-53
FUNCTION: STORE MESSAGE .....	5-54
FUNCTION: TERMINAL OWNER .....	5-55
FUNCTION: TERMINAL PARAMETERS .....	5-56
FUNCTION: SET TERMINAL # .....	5-57
FUNCTION: RESET SEQ # .....	5-58
FUNCTION: SURCHARGE MODE .....	5-59
FUNCTION: SURCHARGE PERCENT .....	5-60
FUNCTION: ENABLE/DISABLE SURCHARGE MODE .....	5-61
FUNCTION: SURCHARGE LOCATION .....	5-62
FUNCTION: BLOCK ISO'S .....	5-63
FUNCTION: SURCHARGE AMOUNT .....	5-65
FUNCTION: CASSETTE SETUP .....	5-66
FUNCTION: LOW CURRENCY .....	5-67
FUNCTION: INTERNATIONAL CURRENCY .....	5-68
FUNCTION: MAXIMUM AMOUNT .....	5-69
FUNCTION: MULTIPLE AMOUNT .....	5-70
FUNCTION: EXTENDED AMOUNTS .....	5-71
FUNCTION: FAST CASH AMOUNT .....	5-72

---

# CONTENTS

---

FUNCTION: KEY MANAGEMENT .....	5-73
FUNCTION: ENTER MAC MASTER KEY .....	5-74
FUNCTION: ENTER PIN MASTER KEY .....	5-76
FUNCTION: INJECT MASTER KEYS .....	5-78
FUNCTION: ENTER MAC WORKING KEY .....	5-79
FUNCTION: ENTER PIN WORKING KEY .....	5-81
FUNCTION: DOWNLOAD WORKING KEYS .....	5-83
FUNCTION: TELEPHONE .....	5-84
FUNCTION: PRIMARY NUMBER .....	5-85
FUNCTION: BACKUP NUMBER .....	5-86
FUNCTION: DATAPAK ACCESS CODE .....	5-87
FUNCTION: PREDIAL ON/OFF .....	5-88
FUNCTION: COMPUSERVE ID .....	5-89
FUNCTION: MODEM SETUP .....	5-90
FUNCTION: DIAL MODE .....	5-91
FUNCTION: DIAL RATE .....	5-92
FUNCTION: BAUD RATE .....	5-93
FUNCTION: MODEM SETUP STRING .....	5-94
FUNCTION: RESET/TEST MODEM .....	5-95
FUNCTION: MORE .....	5-96
FUNCTION: ADJUST VOLUME/CONTR .....	5-97
FUNCTION: RECEIPT OPTION .....	5-98
FUNCTION: TRITON CONNECT .....	5-99
FUNCTION: PRIMARY NUMBER .....	5-100
FUNCTION: BACKUP NUMBER .....	5-101
FUNCTION: ALARM NUMBERS .....	5-102
FUNCTION: PRIMARY ALARM NUMBER .....	5-103
FUNCTION: BACKUP ALARM NUMBER .....	5-104
FUNCTION: ENABLE/DISABLE CALL BACK .....	5-105
FUNCTION: ENABLE/DISABLE TRITON CONNECT .....	5-106
FUNCTION: ATM MONITORING .....	5-107
FUNCTION: STATUS MONITORING .....	5-108
FUNCTION: HEARTBEAT MESSAGE .....	5-109
FUNCTION: AD SCREENS .....	5-112
FUNCTION: COMMUNICATION HEADER .....	5-113
FUNCTION: MORE .....	5-114
FUNCTION: ALARM THRESHOLDS .....	5-115
FUNCTION: SET LOW CASH THRESHOLD .....	5-116
FUNCTION: SET JOURNAL THRESHOLD .....	5-117
FUNCTION: SET SCHEDULED JOURNAL .....	5-118
FUNCTION: VIEW/MODIFY OPTIONS .....	5-119
FUNCTION: ACTIVATE .....	5-120
FUNCTION: DEACTIVATE .....	5-121
FUNCTION: SELECT FEATURE NUMBER .....	5-122
FUNCTION: DATE/TIME FUNCTIONS .....	5-123
FUNCTION: SET DATE FORMAT .....	5-124
FUNCTION: SET DATE / TIME .....	5-125
FUNCTION: SET DATE .....	5-126
FUNCTION: SET TIME .....	5-127

---

Compliments of: [www.atndepot.com](http://www.atndepot.com)

# CONTENTS

---

FUNCTION: TRANSACTION TYPES .....	5-128
FUNCTION: ACCOUNT TYPES .....	5-129
<b>SECTION 6 - MAINTENANCE .....</b>	<b>6-1</b>
CLEANING THE ENCLOSURE .....	6-2
CLEANING THE DISPLAY .....	6-2
CARD READER MAINTENANCE .....	6-2
REPLENISHING THE RECEIPT PRINTER .....	6-3
<b>SECTION 7 - JOURNAL ENTRIES .....</b>	<b>7-1</b>
JOURNAL ENTRIES .....	7-2
<b>SECTION 8 - ERROR RECOVERY .....</b>	<b>8-1</b>
INTRODUCTION .....	8-2
ERROR RECOVERY .....	8-2
RESETTING THE CASH DISPENSER .....	8-3
<b>APPENDIX A - MECHANICAL COMBINATION LOCK INSTRUCTIONS .....</b>	<b>A-1</b>
ABOUT THE DIAL .....	A-2
UNLOCKING 3-NUMBER COMBINATIONS .....	A-2
To Lock .....	A-2
CHANGING THE COMBINATION .....	A-3
<b>APPENDIX B - ELECTRONIC COMBINATION LOCK INSTRUCTIONS .....</b>	<b>B-1</b>
ENTERING COMBINATION .....	B-2
CHANGING COMBINATION .....	B-2
LOCKOUT FEATURE .....	B-2
BATTERY REPLACEMENT .....	B-2
<b>APPENDIX C - WARRANTY AND REPAIR POLICIES/PROCEDURES .....</b>	<b>C-1</b>
PARTS-ONLY LIMITED MANUFACTURER'S WARRANTY .....	C-3
DISCLAIMER OF WARRANTIES .....	C-3
SHIPPING DAMAGE .....	C-4
AUTHORIZED INSTALLATION AND SERVICE PROVIDERS .....	C-4
TRITON'S TECHNICAL SERVICES DEPARTMENT .....	C-5
CONTACT INFORMATION .....	C-6
<b>INDEX .....</b>	<b>I-1</b>

Compliments of: [www.atmdepot.com](http://www.atmdepot.com)



**SECTION 1**  
**INTRODUCTION**

**Compliments of: [www.atndepot.com](http://www.atndepot.com)**

## SECTION 1 - INTRODUCTION

---

### WHAT'S NEW IN ATM SOFTWARE RELEASE 4.1

The newest release of ATM operating software, Version 4.1, offers a number of new features and benefits. These include:

- **IMPROVED MONOCHROME AD GRAPHIC DISPLAY SUPPORT.** The rendering of gray-scale images has been improved significantly. The availability of a more life-like rendering of monochrome graphics can make the use of these images a more appealing option in certain applications.
- **256-COLOR AD GRAPHIC DISPLAY SUPPORT.** ATM Software Release 4.1 delivers support for the new 256-color display feature of Triton Systems ATMs. Ad Graphic screens can now be displayed using a richer palette of 256 colors.
- **“MAC” DATA ENCRYPTION SUPPORT.** ATM Software Release 4.1 implements support for the Message Authentication Code (MAC) data encryption protocol. This capability is typically referred to as “MAC-ing”. This feature provides increased protection for message traffic to and from the ATM. **The SPED option (described next) is required to take advantage of MAC-ing.**
- **SECURE PIN ENTRY DEVICE SUPPORT.** The newest ATM EPROM upgrade, along with Software Release 4.1, support an optional feature of Triton Systems ATMs known as the Secure PIN Entry Device, or SPED. SPED is an encryption system that offers additional protection of the customer PIN during entry at the ATM keypad. **SPED is an option, and is only required if MAC-ing support is desired.**
- **DATAPAK 3000 COMMUNICATIONS PROTOCOL SUPPORT.** ATM Software Release 4.1 is DATAPAK 3000 protocol-compliant. This new capability enables the ATM to interface with designated DATAPAK intermediaries (in the Canadian market region), who in turn provide connectivity to the appropriate transaction processor. DATAPAK 3000 connectivity is typically faster and more cost-effective than a direct dial-up connection between the ATM and the transaction processor. **This feature is only available for ATMs operating in Canada.**

### EPROM UPGRADE REQUIREMENT

The new features of ATM Software Release 4.1 require a corresponding upgrade to the Cash Dispenser's EPROM chip, which is located on the Memory Module. The EPROM version required is SD02.01 or higher.

## SECTION 1 - INTRODUCTION

---

### WHAT'S IN THIS MANUAL

This manual describes all operating features of the following Single-Cassette Cash Dispensers:

- 1.) Model 9600. Front-access, UL291 Business Hours Service Listed.
- 2.) Model 9601. Rear-access, UL291 Business Hours Service Listed.
- 3.) Model 9620. Front-access, UL291 Level 1, 24-Hour Service Listed.
- 4.) Model 9621. Rear-access, UL291 Level 1, 24-Hour Service Listed.

Business Hours Service means that the currency should be removed from the dispenser and stored in a safe location when the business is closed to the public. Level 1, 24-Hour Service means that the dispenser can provide round-the-clock currency protection.

The front-access model Cash Dispensers allow access to the dispensing mechanism and currency cassettes from the interface panel side of the unit. The rear-access models allow equivalent access from the back of the unit.

The setup and operating procedures given in this manual are applicable to the Single-Cassette Cash Dispenser models listed above. If the Cash Dispenser you are using does not have the ability to perform some of the features described in this manual, it is because your *processor* does not support the feature or the dispenser was purchased without that particular option.

In this manual, the terms *Cash Dispenser*, *Dispenser*, or *Terminal* are used interchangeably, and refer to any of the Single-Cassette Cash Dispenser models listed above.

### WHAT IS A CASH DISPENSER?

A Cash Dispenser offers your customers the standard services commonly available from an Automatic Teller Machine (ATM), such as cash withdrawals, transfer of funds between accounts, and balance inquiries.

Once a withdrawal has been completed, the transaction processor (the organization that handles the connection between the terminal and the banking system “network”) automatically debits the customer’s account. The processor credits the merchant’s account for the amount of the withdrawal plus any surcharge (if applicable) at the end of the business day.

As is typically the case with non-bank (“retail”-style) ATMs, the Cash Dispenser does not accept cash deposits.

## SECTION 1 - INTRODUCTION

---

### BALANCING DAILY TRANSACTIONS

The Cash Dispenser keeps track of all transactions and provides simple printed reports to assist in maintaining accurate balance records. The DAY CLOSE function, for example, summarizes the transaction activities of the previous business day. The CASSETTE CLOSE function summarizes the activities since the cash cassette was last loaded.

The exact details of the closing procedure vary slightly, depending upon the sponsoring network. The closing procedures that are applicable in most cases are described in detail in Section 5, Management Functions.

Compliments of: [www.atndepot.com](http://www.atndepot.com)

**SECTION 2  
FEATURES**

**Compliments of: [www.atndepot.com](http://www.atndepot.com)**

## SECTION 2 - FEATURES

### SINGLE-CASSETTE CASH DISPENSERS

The general features of the Single-Cassette Cash Dispenser family are described in Table 2-1:

Table 2-1. Single-Cassette Cash Dispenser Features.

- Front access (models 9600/9620) and rear-access (models 9601/9621) models available.
- UL 291 Business Hours Service (models 9600/9601) or Level 1 (models 9620/9621), 24-Hour Service models available.
- Uses an ordinary dial-up telephone line, instead of an expensive leased line.
- 2400 bps (bits-per-second) modem standard (optional 14400 and 33600 bps modems available).
- Cassette holds approximately 2100 notes (actual capacity depends upon currency quality and thickness) for maximum time between cash replenishment cycles.
- Storage tray integrated into note cassette holds rejected notes for safekeeping and ease of accountability.
- Reliable friction-feed cash dispensing mechanism.
- High-capacity electronic journal can store up to 2045 of the most recent transactions for later printout.
- Intuitive, user-friendly keypad and display interface.
- 320 x 240 dot resolution gray-scale (16 shades of gray) backlit Liquid Crystal Display (LCD). Optional Color LCD display available.
- Flush-mounted magnetic dip-style card reader.
- Fixed-head thermal printer designed for quiet operation.
- Modular design for ease of maintenance.

Figures 2-1 through 2-5 show the various models of the 9600-series family of Cash Dispensers.

### NEW FEATURES

The version 4.1 release of terminal operating software provides significant enhancements to the capabilities of the 9600-series Cash Dispenser. These new features are summarized in the following paragraphs.

- ***Improved Monochrome Graphic Display Support***

The rendering of gray-scale images has been improved significantly. The availability of a more life-like rendering of monochrome graphics can make the use of these images a more appealing option in certain applications.



Figure 2-1. Model 9600 Cash Dispenser.

## SECTION 2 - FEATURES

---

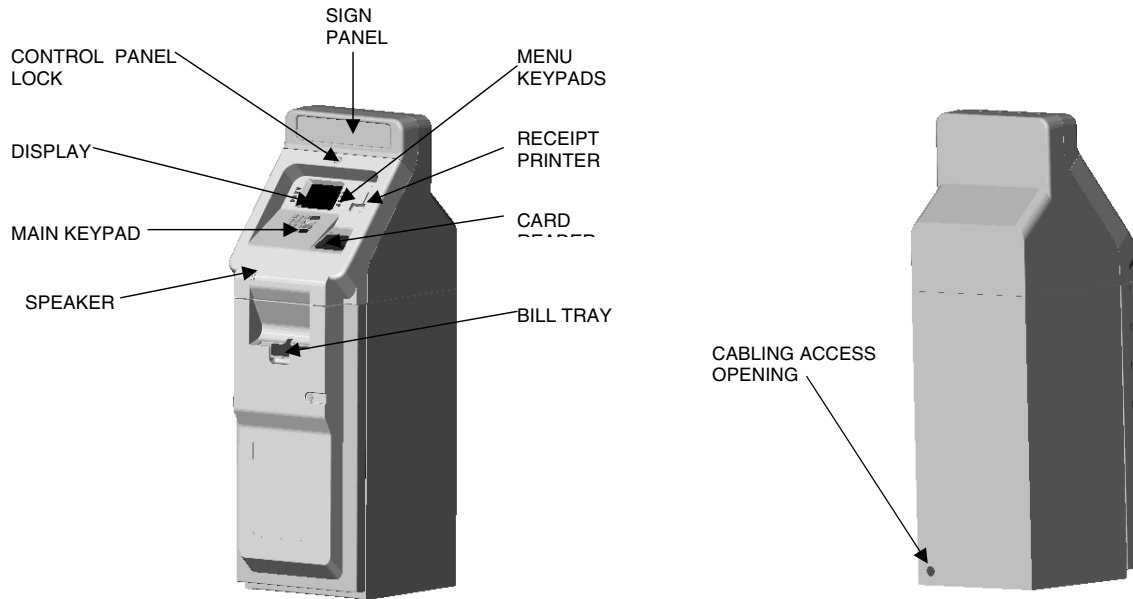


Figure 2-2. Model 9600 Front and Rear Views.

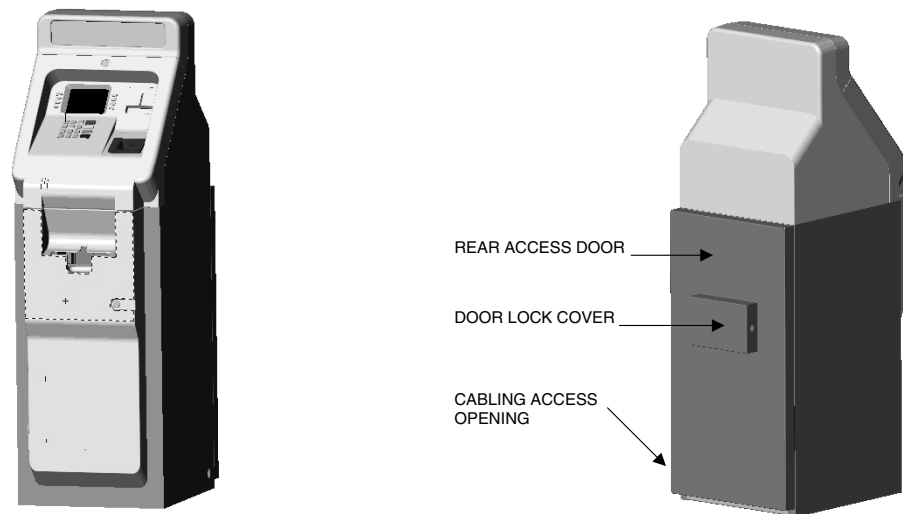


Figure 2-3. Model 9601 Front and Rear Views.

Compliments of: [www.atndepot.com](http://www.atndepot.com)

## SECTION 2 - FEATURES

---

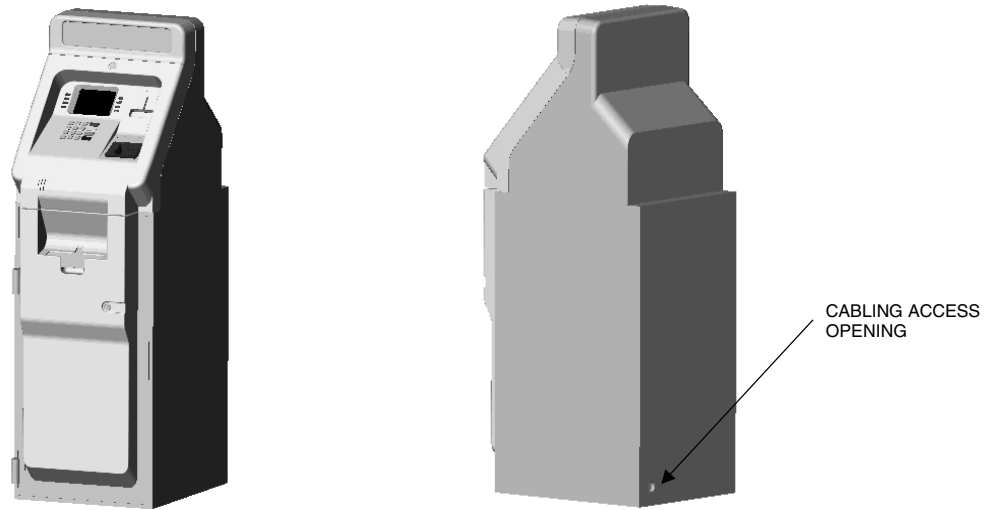


Figure 2-4. Model 9620 Front and Rear Views.

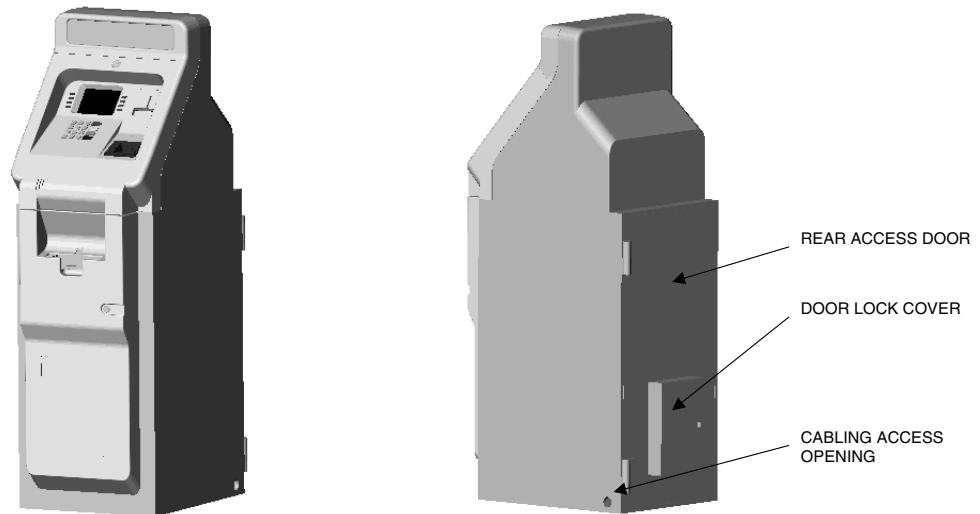


Figure 2-5. Model 9621 Front and Rear Views.



## SECTION 2 - FEATURES

---

- **256-Color Ad Graphic Display Support**

ATM Software Release 4.1 delivers support for the new 256-color display feature of Triton Systems ATMs. Ad Graphic screens can now be displayed using a richer palette of 256 colors.

- **MAC Data Encryption Support**

ATM Software Release 4.1 implements support for the Message Authentication Code (MAC) data encryption protocol. This capability is typically referred to as “MAC-ing”. **NOTE: This feature is currently only available in the Triton Standard version of ATM Software Release 4.1. Also, the SPED option (described below) is required to support MACing.**

MACing Provides increased protection for message traffic to and from the ATM.

- **SPED PIN Entry Device Support**

The newest ATM EPROM upgrade, along with Software Release 4.1, support an optional feature of Triton Systems ATMs known as the Secure PIN Entry Device, or SPED. Note that the SPED option is required in order to support MACing. SPED is an encryption system that offers additional protection for the customer PIN during entry at the ATM keypad.

- **DATAPAK 3000 Communications Protocol Support**

ATM Software Release 4.1 is DATAPAK 3000 protocol-compliant. This new capability enables the ATM to interface with designated DATAPAK intermediaries (in the Canadian market region), who in turn provide connectivity to the appropriate transaction processor. **NOTE: This feature is only available for use in the Canadian market.**

DATAPAK 3000 connectivity is typically faster and more cost-effective than a direct dial-up connection between the ATM and the transaction processor.

### STANDARD FEATURES OF THE SINGLE-CASSETTE CASH DISPENSER

The following paragraphs provide descriptions of the standard features of the Cash Dispenser.

- **Close Scheduling**

This function enables the operator of the terminal to establish a time at which the terminal will automatically initiate a close operation with the processor. If only manual initiation of a close is desired, this feature can be turned off.

## SECTION 2 - FEATURES

---

- ***Exit Message***

This feature allows a message to be displayed to the customer at the conclusion of a transaction. The content of the message is determined by the operator.

- ***Predial Capability***

By initiating the call to the processor immediately after the PIN is keyed in, the actual transaction, once selected, can be completed more quickly. If desired, the predial capability can be disabled, in which case the call to the processor will not be made until after the customer actually chooses a transaction.

- ***Alarm Thresholds***

**NOTE:** This feature must be used in conjunction with Triton Connect version 3.0 or later.

This feature enables the terminal to detect and automatically report the following conditions to a remote personal computer (PC) that is running Triton Connect (version 3.0 or later):

- 1.) The level of cash in the cassette has fallen below a pre-defined threshold.
- 2.) The number of journal entries has risen above a pre-defined threshold.
- 3.) Scheduled transfer of electronic journal data to a remote Triton Connect host computer.  
This time can be set at the terminal or via Triton Connect

- ***Transaction and Account Type Configuration***

This feature enables the terminal operator to select the types of transactions (transfers or balance inquiries) or accounts (savings or credit card) that will be presented to the customer. This feature does not affect the availability of checking account withdrawal transactions, which are always presented.

- ***Electronic Journal***

The Cash Dispenser features a solid state electronic journal, instead of the traditional mechanical journal printer. The electronic journal is based on proven Triton technology and provides improved reliability and ease of use.

The details of each transaction are stored in the journal's memory, and can be retrieved at a later date. When needed, just the information desired can be recalled and a printout of the records made.

## SECTION 2 - FEATURES

---

Normally, journal data is printed by the unit's receipt printer, but with the optional Triton Connect software package the information can be sent to a remote PC (Personal Computer) for storage and subsequent analysis.

The information in the electronic journal is maintained in a safe and secure environment. The journal is physically located in the lower security cabinet of the unit, making it as secure as the cash itself. Even after a transaction record has been printed to the receipt printer, it can still be read and printed again. Old records are retained in the electronic journal until 2045 records have been stored, at which time the journal must be printed or cleared.

The software on the terminal makes it easy to retrieve stored information as often as necessary. From the operator's standpoint, use of the journal is simple. All that is required of the operator is to do a *PRINT JOURNAL* command on a regular basis. Typically, the journal should be printed out whenever a *DAY CLOSE* is completed, although this is not a requirement.

When the *PRINT JOURNAL* command is selected, only the records acquired since the last *PRINT JOURNAL* command will be printed. Therefore, you don't have to keep track of what record was printed last, because the terminal does it for you.

If the printed copy of a group of records is accidentally lost or destroyed, or the receipt printer runs out of paper before completely printing a group of records, it is a simple matter to reprint them, since they remain stored in the journal (until overwritten, as explained earlier).

- ***Distributor EPROM Access With Challenge***

This feature provides increased security by allowing each distributor to select their own unique EPROM access code for each terminal they sell or service. Procedures for entering and changing the EPROM Access Code are contained in the Cash Dispenser Installation and Service Manual.

- ***Status Monitoring***

This feature (not available with all versions of the terminal's operating software) allows information about the operational status of the terminal to be provided to the processor. The feature is activated using the terminal's Management Functions.

- ***Language Option***

The Cash Dispenser has a screen language option. This option allows the terminal user to select a preferred language (such as Spanish) when beginning an ATM transaction.

## SECTION 2 - FEATURES

---

- ***International Monetary Support***

This feature allows installation and service personnel to select one of a number of monetary symbols (such as C, ¢, \$, f, L, P<sub>t</sub>, £, Q, ¥) that describe the type of currency that will be dispensed by the Cash Dispenser. The default symbol can be viewed and changed through the Management Functions.

- ***Six-Digit Amount Entry Fields***

U.S. domestic versions of the terminal operating software allow up to six digits to be entered in all fields where a cash amount is expected. Some international versions of the software allow extended field-lengths (see Extended Fields).

- ***Receipt Printer Paper Low Option***

This feature allows the end user to determine whether or not the terminal is allowed to continue processing transactions when the receipt printer paper is low.

- ***Quad-Port Module***

The Quad-Port Module is a serial interface board that provides four independently assignable and software configurable serial I/O ports. These ports are RS-232C compliant interfaces that can support baud rates through 33,600 baud.

The capabilities of the module are such that new Cash Dispenser features that require serial interfaces can readily be supported. The LED Sign is an example of an option that requires the Quad-Port Module.

- ***Memory Expansion Modules***

To take advantage of the new graphics handling features of the Cash Dispenser, the terminal must be equipped with at least one Memory Expansion Module. Memory Expansion Modules are available with the following memory capacity:

- 1 Megabyte (Part Number 9600-0004)
- 2 Megabytes (Part Number 9600-0031)
- 4 Megabytes (Part Number 9600-0032)

Two Memory Expansion Modules can be installed in slots four and five of the terminal's Electronic Enclosure.

## SECTION 2 - FEATURES

---

### Jumper Settings

Memory Expansion Modules have jumpers that must be installed in the right position to operate correctly. The Memory Expansion Module installed in slot 4 of the card cage must have the jumpers across pins 1 and 2 of J1 and J2. If a second Memory Expansion Module is installed, it will be put in slot 5 of the card cage. The jumpers on the second Module must be installed across pins 2 and 3 of J1 and J2.

### Formatting a Memory Module

A Memory Expansion Module is formatted so that it is ready to accept downloaded files from the Triton Connect Host Computer. All Single-Cassette Cash Dispenser Memory Expansion Modules are shipped from the factory formatted. If it becomes necessary to format a Memory Expansion Module, it can be accomplished by two methods.

#### Formatting a Memory Expansion Module from a Triton Connect Host Computer

The first method uses Triton Connect to send a message to the terminal from the Triton Connect Host Computer that tells it to format a Memory Expansion Module. It uses the Reformat Memory Options found in the Ad Graphics/File Manager folder of the Terminal Parameters Option in the Triton Connect Terminal Manager to format the Module. There are separate options to format memory modules 1 and 2.

#### Formatting a Memory Expansion Module at the Local Terminal

The Memory Expansion Modules can also be formatted from the local terminal through the Management Functions. Refer to Section 5, Management Functions, for procedures.

- **AD Screens**

An Ad Screen is a promotional or advertising graphic that is displayed on the Cash Dispenser LCD screen. It is displayed alternately with the Customer Welcome screen graphic (while the terminal is idle) and while a customer transaction is being processed. Triton Connect Software Release 1.8 or higher is required to support the use of AD Screens.

Triton Connect has the ability to format 16-bit color graphics for use in AD Screens (this requires the optional 16-color LCD display), to format monochrome graphics for use in receipt printouts, and to create text-based messages.

## SECTION 2 - FEATURES

---

Once formatted, the graphics and text-based messages can be downloaded to a terminal by the Triton Connect host computer. The time of day a specific Ad Screen is displayed and the duration it will be displayed can also be controlled.

To display AD Screens a terminal must have at least one optional Memory Expansion Module installed. All Cash Dispensers can display text-based Ad Screens with no additional hardware.

- **Text-Based AD Screens**

Text-based AD Screens can be displayed to the customer while the terminal is performing a transaction. A maximum of four text-based ads can be displayed during the interval that the “Transaction Processing - Please Wait” message screen is being shown to the customer. Each ad consists of up to eight lines of text, and each ad can be displayed for an operator-specified duration. The messages are created and downloaded to the terminal using Triton Connect Software Release release 1.8 or above.

- **Receipt Printer Graphics**

Triton Connect Software Release 1.8 or higher allows a bit-mapped graphic image in “.bmp” format to be downloaded to the terminal. This graphic is printed on the receipt when the PRINTED GRAPHIC option is enabled through the Management Functions. This feature requires the addition of a Memory Expansion Module.

- **Prize Coupons Option**

The Cash Dispenser may be configured to award “prize coupons” to customers on a random chance or a withdrawal amount-determined basis. Coupons are awarded as printed messages presented to the customer on a separate receipt. The messages consist of four lines of text, with up to 40 characters in each line. The text of the message is entered from the terminal’s keypad.

There are two methods of awarding coupons. The RANDOM approach awards coupons randomly within a specified percentage range (such as 3% of transactions) set in the management Functions.

The LEVEL approach awards a coupon to each customer that withdraws an amount equal to or greater than a specific dollar value that is set in the Management Functions.



Figure 2-6. Prize Coupons.

## SECTION 2 - FEATURES

---

When a coupon is awarded, the cash dispenser beeps a distinctive tone, displays a message to alert the customer and prints a coupon after the money is dispensed (but before the customer receipt is printed). The prize coupon is printed on a separate receipt and a full cut is made between the coupon and the customer receipt.

- **Receipt Option**

This feature gives customers the option of receiving or not receiving a receipt after completing a withdrawal transaction. The factory default for the RECEIPT OPTION is disabled, meaning a receipt will always be issued after each withdrawal transaction.

If the RECEIPT OPTION is enabled, the customer is given the option of choosing to receive or not receive a printed receipt at the end of the withdrawal transaction. If the customer fails to make a choice, the receipt will be printed automatically after a 40-second delay.

- **Color Display Option**

The Cash Dispenser can be equipped with an optional 16-color LCD display. As with the standard gray-scale display, the customer is guided through a transaction by selecting various options from menus that are presented on the LCD. Additionally, the terminal has the capability of displaying promotional information (AD Screens) in color while it is idle or when the customer is waiting for a transaction to be completed.

- **Triton Connect™**

Triton Connect is an optional software package available through your service provider that facilitates remote data retrieval and monitoring of your Triton Systems Cash Dispenser. The advantages of this feature are reduced service calls and simplified terminal configuration changes, which in turn provides more immediate and economical service for you.

The Triton Connect software runs on a remote host computer, and uses standard dial-up telephone lines to access and monitor the terminal. Triton Connect operates by dialing up the terminal and retrieving its data.

The Triton Connect host computer can monitor your Cash Dispenser 24 hours a day, seven days a week, and can receive an incoming call *from the Cash Dispenser* if there is a system error or service is required.

The Terminal Configuration options in the Management Functions area enable you to activate or deactivate Triton Connect access to the terminal.

## SECTION 2 - FEATURES

---

Key information about the status of the terminal is collected and stored at a central location by your service provider. With this data, customer transaction reports can be developed that make it easy to monitor your Cash Dispenser's performance, schedule cash replenishment, and provide instant status for service dispatch should a problem occur.

- ***Extended Amounts***

The standard length of a currency amount entry field is 6 characters in U. S. domestic versions of the terminal operating software. In some international applications this length is insufficient to allow the entry of the full range of monetary values available in the local currency type. The Extended Amounts feature allows the selection of 12-character currency amount entry fields for those applications that require it.

Once selected, the Cash Dispenser can accept the entry of extended amounts for customer withdrawal and transfer transactions. The feature is activated using the terminal's Management Functions.

- ***LED Sign Option***

This option consists of a display panel and associated hardware and firmware that enables a Cash Dispenser to display messages and animated themes using a variety of special effects. The LED Sign is available in either Lowtopper or Hightopper versions.

The LED Sign requires version 3.0 (or higher) Terminal Software, a Quad-Port Module, and a version SD01.04 (or higher) EPROM. To control the LED Sign, you will need Triton Connect for Windows 95, version 1.9.1 or later. The LED Sign can also be operated using an optional hand-held infrared remote control.

Specific instructions for operating the LED Sign are contained in the Triton Connect User Manual, or the LED Sign Remote Control Operation Manual, as applicable.

- ***Date/Time Format***

This option allows the operator to select either MM/DD/YY or DD/MM/YY as the format the terminal will use when printing receipts and other reports.

- ***Dispense Counter***

This feature counts the number of bills that have been dispensed from the currency cassette and prints the total on the Receipt Printer Test report



**SECTION 3**  
**OPERATION AND SETUP**

**Compl i ments of: [www. atndepot. com](http://www.atndepot.com)**

## SECTION 3 - OPERATION AND SETUP

---

### BASIC OPERATION

This chapter describes the basic operation and setup of the Cash Dispenser. The procedures are applicable to any of the Single-Cassette Cash Dispensers in the model 9600/9601/9620/9621 product line.

### MENU-BASED OPERATION

The Cash Dispenser operates as a menu driven system. Messages and menu options presented on the LCD display screen guide the user's actions. The desired menu option is selected by pressing one of the screen keys located to the left and right of the display (see Figure 3-2). For the purpose of security many screens *timeout* after a preset time interval, usually 30 seconds. The timeout length may vary depending on the function being performed.

When a screen timeout occurs, a screen is presented which asks the user if more time is needed. If the user chooses NO, the Customer Welcome screen will be presented. If YES is chosen, the user is returned to the function that was active prior to the timeout. If the user does not make a selection within an additional 30-second countdown period the Cash Dispenser will automatically go to the Customer Welcome screen.

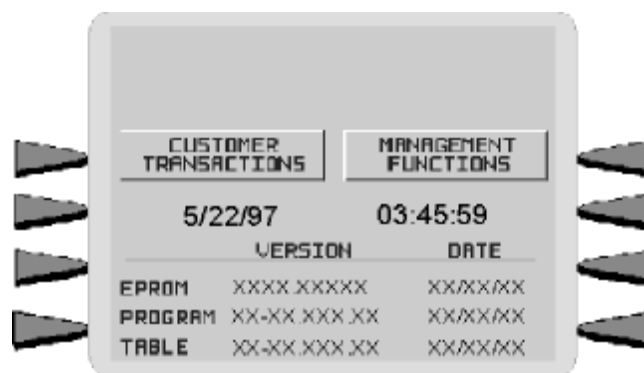


Figure 3-1. The TOP MENU display.

When the unit is turned on, the dispenser will beep once and the Top Menu, shown in Figure 3-1, will appear on the display screen after a few seconds. From the Top Menu, you can either:

- 1.) Activate the Cash Dispenser to perform customer transactions by pressing the key next to CUSTOMER TRANSACTIONS.

## SECTION 3 - OPERATION AND SETUP

2.) Enter the Cash Dispenser system management area by pressing the key next to MANAGEMENT FUNCTIONS.

If you do not select a menu choice within 30 seconds the Cash Dispenser will automatically default to the Customer Welcome screen (a benefit of this feature is that in the event of a power interruption the terminal will automatically begin accepting customer transactions shortly after power is restored).

### KEYPAD OPERATION

The user interface of the Cash Dispenser consists of the LCD display and 24 rubber keys on three keypads. The primary menu navigation keys are arranged in two four-key groups, one group on either side of the LCD display. The main keypad consists of 10 alphanumeric keys, two arrow keys and four large control keys, all located in a 16-key group beneath the LCD display.



Figure 3-2. Cash Dispenser Keypad.

All of the keys that a customer would use to conduct transactions have an integral raised Braille symbol to conform to the requirements of the Americans with Disabilities Act. To activate a key, press it until a beep is heard. If the key does not beep, it means that the key is not active for the current function, or the key was not pressed firmly enough.

The entry of numeric characters via the keypad is straightforward: simply press the desired key. However, in certain management function screens it may be necessary to enter alphabetic characters, a procedure that requires a little more explanation. On such screens a flashing cursor will be evident on the display, representing the location where the next character you enter will be displayed. To enter a letter or punctuation mark, you will first press the <BLUE> key, and then you will press the number that has the letter or other character you want.

Each of the numbered keys (<0> through <9>) has six characters available. See Figure 3-3, Alphanumeric Keypad, and Table 3-1, Keypad Characters. On most of these keys (<2> through <9>), the first three of the available characters are alphabetic, and are printed on the keycap above the number character. Two keys, the <0> and <1>, are different. The <0> key does not show any additional characters, while the <1> key shows two alphabetic characters ('QZ').

Compliments of: [www.atmdepot.com](http://www.atmdepot.com)

## SECTION 3 - OPERATION AND SETUP

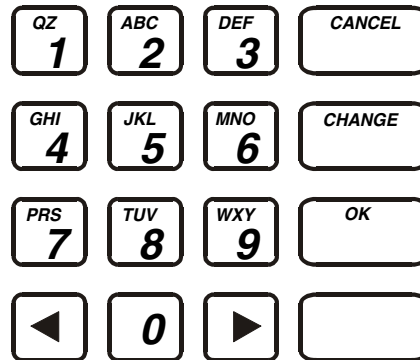


Figure 3-3. Alphanumeric Keypad.

KEYPAD CHARACTERS						
	X1	X2	X3	X4	X5	X6
1	Q	Z	Space	~	!	@
2	A	B	C	#	\$	%
3	D	E	F	^	*	_
4	G	H	I	(	)	
5	J	K	L	\	/	"
6	M	N	O	;	:	' Single Quote (Open)
7	P	R	S	?	<	>
8	T	U	V	[	]	ñ
9	W	X	Y	{	}	' Single Quote (Close)
0	,	.	-	&	=	+

Table 3-1. Keypad Characters.

The first character *on the first key (0-9) you press after the <BLUE> key* will be displayed at the current cursor position. Pressing the same key repeatedly will cycle the displayed letter through the available character choices for that key (X1-X6). When the desired character is displayed, press the <RIGHT ARROW> key to 'lock it in' and move the cursor to the next position. Repeat these steps to enter the next character.

## SECTION 3 - OPERATION AND SETUP

---

The <RIGHT ARROW> and <LEFT ARROW> keys are used in most alphanumeric data entry situations. The <LEFT ARROW> is used to back up and erase a character. The <RIGHT ARROW> is used to lock in a character. These keys will auto-repeat if held down for more than one second.

The <CHANGE> key can be used to clear an entry and start over. The <CANCEL> key will abort the current transaction.

The keys located beside the display are called the Screen Keys. They are used in the selection of menu functions. A Screen Key is only active when a function or menu option name is displayed beside the key.

### CHANGING TO MANAGEMENT FUNCTIONS

You can enter the terminal MANAGEMENT FUNCTIONS main menu screen by performing any one of the three procedures listed below:

1. The Customer Welcome screen shows an animation of a hand inserting and removing a card, with a message describing how to begin a transaction. If this screen is being displayed, press and hold down the <BLUE> key; while holding down the <BLUE> key, press the <1> key. Release both keys. After a moment the Top Menu screen (shown in Figure 3-1) will be displayed. Select the MANAGEMENT FUNCTIONS option.
2. Reset the Cash Dispenser by pressing and releasing the Reset Switch found on the front panel of the Memory Module, which is located in the card cage inside the upper enclosure of the terminal. When the Top Menu is displayed select MANAGEMENT FUNCTIONS.
3. Remove and then reapply power to the terminal using the ON/OFF switch located on the right side of the card cage inside the upper enclosure of the terminal. When the Top Menu is displayed select MANAGEMENT FUNCTIONS.

The Top Menu allows you to choose one of two options, CUSTOMER TRANSACTIONS or MANAGEMENT FUNCTIONS. Selecting CUSTOMER TRANSACTIONS changes the display to the Customer Welcome screen so the Cash Dispenser is ready to perform customer transactions. Selecting MANAGEMENT FUNCTIONS opens the password screen, which in turn provides access to menus that are used for changing or viewing terminal parameters.

## SECTION 3 - OPERATION AND SETUP

---

Whenever the MANAGEMENT FUNCTIONS choice is selected, the Cash Dispenser will ask for a password to be entered. For a first-time configuration, enter the default MASTER PASSWORD of '123456' on the keypad and then press the <OK> key. This 'default' password will be valid until it is changed.

### **\*\*NOTE\*\***

**The operator of the Cash Dispenser must change the MASTER PASSWORD to a new number when the installation is complete.**

The Top Menu serves an alternative purpose in the event of a machine malfunction or other error condition. Such conditions are normally reported by an "OUT OF SERVICE" message screen. The typical response to this message is to reset the Cash Dispenser. After resetting the Cash Dispenser the Top Menu screen will display any applicable status messages and error code numbers.

The two options presented in such instances will be RESET ERROR and MANAGEMENT FUNCTIONS. Press RESET ERROR to attempt to clear the error, or enter the MANAGEMENT FUNCTIONS area, as desired. See Section 8, Error Recovery, for more information.

### **INITIAL CASH DISPENSER CONFIGURATION**

There are a number of configuration parameters that must be set when a Cash Dispenser is installed. These parameters do not need to be set in any particular order, but they **MUST** be entered into the Cash Dispenser to enable customer transactions to take place. Once they are set, they are retained internally, even when the Cash Dispenser is turned off.

Detailed procedures describing the step-by-step setup of each terminal parameter are located in Section 5 of this manual.

- ***Terminal Number***

The TERMINAL NUMBER is a unique string of alphanumeric characters (numbers and/or letters) that identifies your Cash Dispenser to the processor. The TERMINAL NUMBER is assigned to your Cash Dispenser by your processor

The TERMINAL NUMBER and TELEPHONE NUMBER **MUST** be set before the Cash Dispenser can go on-line and before the *communications key* can be downloaded.

## SECTION 3 - OPERATION AND SETUP

---

- **Telephone Number**

The Cash Dispenser communicates to your host processor over a dial up phone line. The phone number of the processor must be entered before live transactions can be performed.

- **Surcharge Mode**

Some networks allow a surcharge, or terminal fee, to be imposed on withdrawal transactions. If surcharges are in use on your network, you are required to notify the customer of the possibility of an additional fee before the transaction is processed. The customer must be given a chance to cancel the transaction.

Setting the SURCHARGE MODE to ENABLED will cause the surcharge warning screen to be displayed after the customer's card is inserted. The surcharge warning screen notifies the customer of a possible fee and its amount. The customer is given the opportunity to cancel the transaction at no charge or to accept the surcharge and continue with the transaction.

If your network does not allow surcharges, the SURCHARGE MODE must be set to DISABLED.

The amount of the surcharge is stored in the Cash Dispenser and displayed to the customer. The SURCHARGE AMOUNT displayed on the screen can be set manually via the SURCHARGE AMOUNT menu. In some cases this value is downloaded from the processor at the same time the communications key is downloaded.

Manually changing the SURCHARGE AMOUNT to a different value does not automatically change the surcharge collected by the processor for a transaction. *It will only change the surcharge in the surcharge-warning message shown to the customer and NOT the actual fee collected for the transaction, so be sure the values are the same AND are accurate!*

- **Multiple Amount**

This is the value of the denomination of the cash in the currency cassette. It must be set to a value that is *at least 1/50th of the MAXIMUM AMOUNT*. For example, if the MAXIMUM AMOUNT is 500.00, then the MULTIPLE AMOUNT must be at least \$10.00 (\$20.00 would also work). A value of \$5.00, however, could not be used unless the maximum amount was set no greater than \$250.00 (\$5.00 X 50=250).

The factory default for the MULTIPLE AMOUNT is \$0.00.

## SECTION 3 - OPERATION AND SETUP

---

- **MAC Master/Working Keys**

The MAC Master and Working keys are only used if an optional Secure Pin Entry Device (SPED) keypad has been installed and MAC-ing is being implemented.

The MAC MASTER KEY is used to decrypt the MAC WORKING KEY. Each key is a 16-character string, consisting of a combination of the digits 0-9 and the letters A-F. The MAC MASTER KEY may be injected from a personal computer (using a special floppy disk), or entered manually at the keypad.

- **PIN Master/Working Keys**

The PIN MASTER KEY is used to decrypt the PIN WORKING KEY. The Pin MASTER KEY was referred to as the MASTER KEY in previous versions of ATM operating software. The PIN WORKING KEY was referred to as the COMMUNICATIONS (COMMS) KEY. Each key is a 16-character string, consisting of a combination of the digits 0-9 and the letters A-F. The PIN MASTER KEY may be entered manually, or may be injected from a personal computer, using a special floppy disk. The PIN WORKING KEY may be entered manually or downloaded from the processor.

### ADDITIONAL SETUP PARAMETERS

In addition to the configuration parameters described in the previous paragraphs, there are several other parameters that will need to be entered into the Cash Dispenser to complete its setup. The procedures for setting each of these parameters are found in Section 5 of this manual. Some parameters are processor-specific and may not be available for all locations.

- **Maximum Amount**

The maximum withdrawal limit must be entered into the Cash Dispenser before any transactions can be completed. This number is the largest dollar amount allowed for a single withdrawal transaction. The MAXIMUM AMOUNT may be set from \$1 to \$999 in increments of \$1 and must be set to a multiple of the denomination of the currency in the cassette. Factory default is set to \$500.00. The value must be a whole dollar amount only.



## SECTION 3 - OPERATION AND SETUP

---

Whenever a withdrawal transaction is processed, the amount entered or selected is compared to the **MAXIMUM AMOUNT** parameter. If the entry is larger, an error message warns the user and displays the maximum allowable amount. Additionally, *the MAXIMUM AMOUNT cannot be more than 50 times greater than the denomination of the currency in the cassette.*

The **MAXIMUM AMOUNT** entered into the Cash Dispenser **DOES NOT** override any maximum set by a network. The transaction will be sent to the network if the amount entered or selected is less than the maximum. The network must still approve the requested amount.

- **Store Message**

The Store Message consists of up to four lines of text that are printed at the top of each receipt and report. This message is typically used to print the store name, address and phone number.

- **Marketing Message**

The Marketing Message consists of up to four lines of text that are printed at the top of each receipt and report (if a Store Message is used, the Marketing Message is printed below it). This message can be used for advertising purposes, sales notifications, promotions, or other purposes.

- **Surcharge Owner**

The name of the surcharge owner is stored in the terminal and printed on the receipt.

- **Terminal Owner**

The name of the Terminal Owner is stored in the terminal and displayed to the customer in the surcharge-warning message.

- **Welcome Message**

The Welcome Message consists of three lines of text that are displayed on the Customer Welcome screen.

## SECTION 3 - OPERATION AND SETUP

---

- ***Language Option***

This feature allows the terminal operator to select the language that is displayed to the customer during a transaction, as well as the language in which the Management Functions are presented. A feature is also provided that gives the customer the option of selecting a preferred language. Also, some terminal software versions allow receipts to be printed using the non-English language choice.

- ***Receipt Option***

This feature allows the customer to select the option of receiving or not receiving a receipt at the completion of a transaction.

- ***Coupon Options***

Coupons are used for promotional purposes. The owner of the Cash Dispenser can use the Coupon Options feature to issue printed coupons from the receipt printer. Coupons are issued randomly (based on percentage) or whenever a customer uses the Cash Dispenser to withdraw more than a predetermined minimum amount of cash.

- ***Date/Time Format***

This option allows the operator to select either MM/DD/YY or DD/MM/YY as the format the terminal will use when printing receipts and other reports.

### SETUP PARAMETERS LISTING

Table 3-2, Single-Cassette Cash Dispenser Setup Parameters, lists all of the operator-configurable parameters accessible through the Management Functions. References to the specific pages in Section 5, Management Functions, are provided to help quickly locate the description and applicable setup instructions for each parameter. In most cases the factory default value of each parameter is also provided.

Although many of the parameters have been set at the factory, it is important to verify that the settings are appropriate. Certain default values are merely ‘place holders’ and should be changed to reflect the actual settings and values required. Review the table and take the time to make the necessary changes and updates as needed to ensure the terminal is completely setup, customized for its intended application, and ready to operate.

# SECTION 3 - OPERATION AND SETUP

SINGLE-CASSETTE CASH DISPENSER SETUP PARAMETERS					
FUNCTION/PARAMETER	FACTORY DEFAULT	PAGE NO.	FUNCTION/PARAMETER	FACTORY DEFAULT	PAGE NO.
<b>CLOSE</b>			<b>36</b>	EXTENDED AMOUNT	DISABLED
1	SCHEDULE CLOSE	OFF	5-7	37	FAST CASH AMOUNT
2	CHANGE SCHEDULE	*	5-8	38	ENTER MAC MASTER KEY
3	SEND TERMINAL TOTALS	OFF	5-12	39	ENTER PIN MASTER KEY
4	ENTER QTY. IN CASSETTE	0	5-13	40	INJECT MASTER KEYS
<b>LANGUAGE / IDIOMA</b>			<b>41</b>	ENTER MAC WORKING KEY	*
5	ENGLISH/INGLES	*	5-26	42	ENTER PIN WORKING KEY
6	SPANISH/ESPAÑOL	*	5-27	43	DOWNLOAD WORKING KEYS
7	ENABLE/DISABLE CUST. OPTION	DISABLED	5-28	43	PRIMARY NUMBER (TELEPHONE)
<b>PASSWORD MAINTENANCE</b>			<b>44</b>	BACKUP NUMBER (TELEPHONE)	NONE
8	MASTER PASSWORD	123456	5-34	45	DATAPAK ACCESS CODE
9	ADMINISTRATION PASSWORD	987654	5-35	45	PREDIAL ON/OFF
<b>PRINTER SETTINGS</b>			<b>46</b>	COMPU SERVE ID	*
10	SET PRINT LENGTH	35	5-38	47	DIAL MODE
11	LOW RECEIPT PAPER	OFF	5-39	48	DIAL RATE
12	PRINTER GRAPHICS	ENABLED	5-40	49	BAUD RATE
<b>RANDOM / LEVEL PRIZE COUPONS</b>			<b>50</b>	MODEM SETUP STRING	*
13	ENTER LEVEL PRIZE MESSAGE	*	5-42	<b>MORE TERMINAL PARAMETERS</b>	
14	ENTER RANDOM PRIZE MESSAGE	*	5-43	51	ADJUST VOLUME/CONTRAST
15	ENABLE/DISABLE COUPON AWARD	DISABLED	5-44	52	RECEIPT OPTION
16	SET LEVEL PRIZE AMOUNT	\$0.00	5-45	53	PRIMARY NUMBER (TRITON CONNECT)
17	SET RANDOM WINNING %	0%	5-46	54	BACKUP NUMBER (TRITON CONNECT)
<b>CHANGE MESSAGES</b>			<b>55</b>	PRIMARY ALARM NUMBER	NONE
18	MARKETING MESSAGE	*	5-48	56	BACKUP ALARM NUMBER
19	SURCHARGE MESSAGES	*	5-49	57	ENABLE/DISABLE CALLBACK
20	WELCOME MESSAGE	*	5-51	58	ENABLE/DISABLE TRITON CONNECT
21	SURCHARGE OWNER	*	5-52	59	STATUS MONITORING
22	EXIT MESSAGE	*	5-53	60	HEARTBEAT MESSAGE
23	STORE MESSAGE	*	5-54	61	AD SCREENS
24	TERMINAL OWNER	*	5-55	62	ENABLE/DISABLE COMMUNICATION HEADER
<b>SET TERMINAL PARAMETERS</b>			<b>63</b>	CHANGE COMMUNICATION HEADER	*
25	SET TERMINAL #	NONE	5-57	64	ALARM THRESHOLDS ON/OFF
26	SURCHARGE PERCENT	0%	5-60	65	SET LOW CASH THRESHOLD
27	LESSER/GREATER SELECTION	LESSER	5-60	66	SET JOURNAL THRESHOLD
28	ENABLE/DISABLE SURCHARGE	DISABLED	5-61	67	SET SCHEDULED JOURNAL
29	SURCHARGE LOCATION	BEGINNING	5-62	68	VIEW/MODIFY OPTIONS
30	BLOCK ISO'S	NONE	5-63	<b>TERMINAL CONFIGURATION</b>	
31	SURCHARGE AMOUNT	\$0.00	5-65	69	SET DATE FORMAT
32	LOW CURRENCY	ENABLED	5-67	70	SET DATE
33	INTERNATIONAL CURRENCY	*	5-68	71	SET TIME
34	MAXIMUM AMOUNT	\$500.00	5-69	72	TRANSACTION TYPES
35	MULTIPLE AMOUNT	\$0.00	5-70	73	ACCOUNT TYPES

\*REFER TO SECTION 5, MANAGEMENT FUNCTIONS, FOR INFORMATION ON THE FACTORY DEFAULTS FOR THESE FUNCTIONS.

Compliments of: [www.atndepot.com](http://www.atndepot.com)

**For Sales & Service Call: 888-501-5246**

**Compliments of: [www.atmdepot.com](http://www.atmdepot.com)**

**SECTION 4**  
**HANDLING CASSETTES**

**Compl i ments of: [www.atndepot.com](http://www.atndepot.com)**

**For Sales & Service Call: 888-501-5246**

## SECTION 4 - HANDLING CASSETTES

### MEDIA CONDITION

Documents loaded into the currency cassette must be in “fit” condition if a high level of performance (low reject and failure rate) is expected from the Cash Dispenser. “Fit” documents are defined as those that do not possess any of the defects listed below:

- **Used Currency**

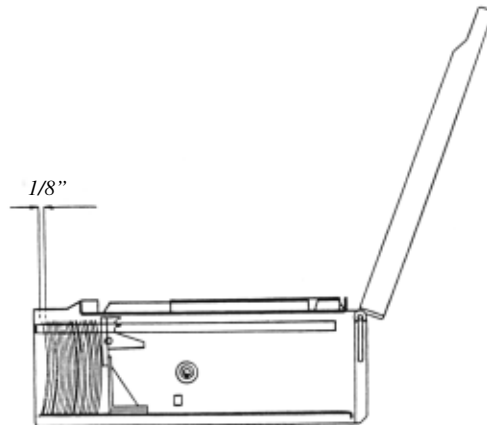
“Fit” used currency does not possess any of the following defects:

- Sticky substances on the surface of the paper.
- Tears extending more than 1/2” from the edge of the currency.
- Tears, holes, or missing sections in the body of the currency.
- Tape on the surface of the currency used for repairing, patching or any other purpose.
- Staples, pins, or any other foreign objects attached to the currency.
- Corner folds of a size greater than 1/2” on either axis.
- Two or more sheets of currency joined by any means.
- Nearly new currency which has been excessively crumpled or crinkled.

- **New or Uncirculated Currency**

“Fit” new or uncirculated currency does not possess any of the following defects:

- All the conditions listed above for used currency.
- Excessive bowing due to conditions of packing and storing. Any curvature greater than 1/8” is unacceptable. If notes are bowed, the loading orientation must be as shown in Figure 4-1.
- New or uncirculated currency must be “burst” and fully separated prior to loading into cassettes.



*If the Cassette is to be loaded with bowed notes, the direction of the bow must be as shown and not exceed 1/8” (in a relaxed state).*

*Figure 4-1. The orientation of bowed notes.*

### REPLENISHING CASSETTES

1. Open the Cash Dispenser security container via the enclosure lock on the front of the unit. The combination lock must then be opened to gain access to the security container.

## SECTION 4 - HANDLING CASSETTES

- To remove the cassette, grasp the handle on the front of the Cash Dispenser mechanism with one hand while holding the mechanism in place with the other hand (See Figure 4-2) and pull sharply.

**\*\*\*CAUTION\*\*\***

**Do not allow the cassette to swing freely when it is pulled out. It may strike a nearby object or person causing damage to or injury to what it strikes.**

- The cassette must be primed with the cassette key before it can be inserted onto the loading tray. Insert the key and turn clockwise to show the green indicator in the window on the side of the cassette. Refer to Figure 4-3 and Figure 4-4.

**\*\*\*CAUTION\*\*\***

**If red is indicated in the window on the side of the currency cassette, never attempt to insert the cassette into the Cash Dispenser or the loading tray.**

- Place the cassette onto the loading tray with the back of the cassette facing the probes on the tray as shown in Figure 4-4. The shutter is unlocked as the cassette is pushed into the probes.
- Lift the cassette lid to expose the reject tray as shown in Figure 4-5. Remove any rejected notes. Lift the reject tray to gain access to the currency compartment.

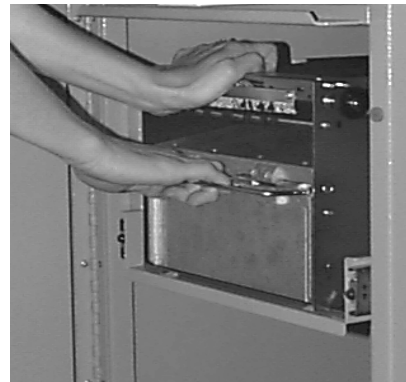


Figure 4-2. Removing a cassette from the Cash Dispenser.

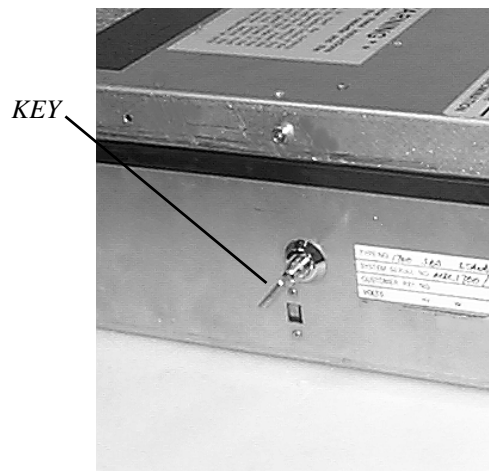


Figure 4-3. Priming the cassette.



Figure 4-4. Currency cassette on a loading tray.

Compliments of: [www.atndepot.com](http://www.atndepot.com)

## SECTION 4 - HANDLING CASSETTES

6. Pull the packer plate to the rear of the cassette (away from the shutter) until it locks to the white packer plate latch as shown in Figure 4-6. It will be necessary to push down on the packer plate latch to lock the packer plate in place. The packer plate will be held in this position until the lid is closed or the latch is released by pushing it down. Be careful not to release the packer plate onto your fingers.
7. Place the currency into the cassette. Allow at least one inch of clearance between the packer plate when it is fully retracted and the currency. This will allow the packer plate to compress the currency as shown in Figure 4-7. If you are changing the denomination of the bills in the cassette, you must change the MULTIPLE AMOUNT parameter in the Cash Dispenser to match (refer to Section 5 - Management Functions for procedures). Release the packer plate and lower the reject tray and the lid. The cassette can now be removed from the loading tray by sliding it forward.
8. Verify that the cassette is primed. Be certain the green indicator is showing in the window below the key. Install the cassette into the Cash Dispenser as shown in Figure 4-8 by placing the cassette guides on the dispensers' rails and firmly pushing the cassette in until it locks in place.
9. Close and lock the Cash Dispenser.

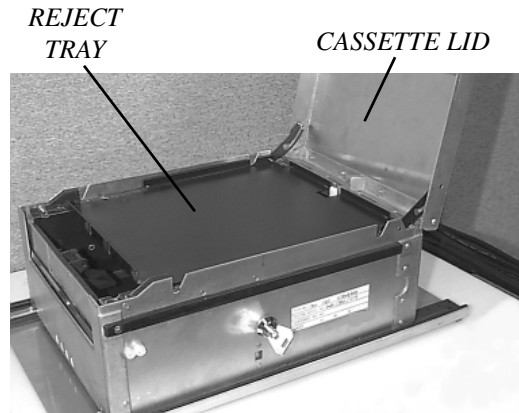


Figure 4-5. Cassette showing the reject tray.

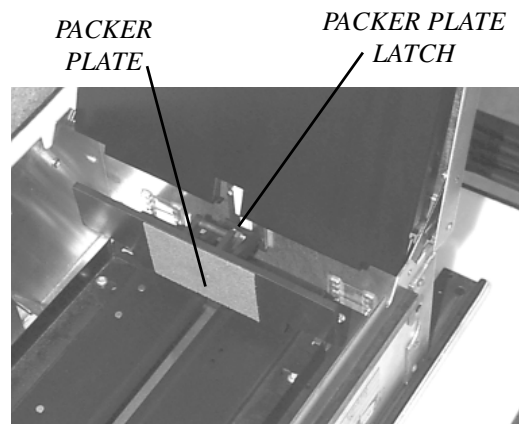


Figure 4-6. Packer plate latched at the rear of the cassette.

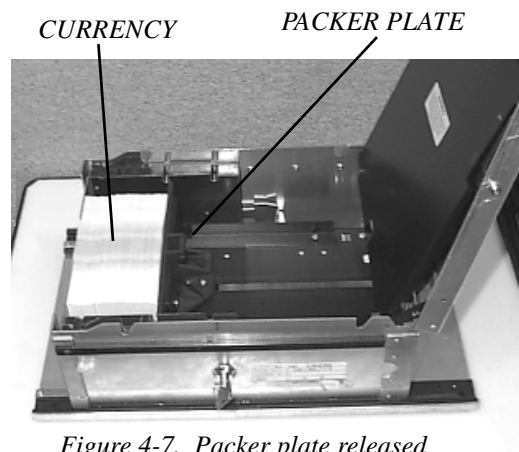


Figure 4-7. Packer plate released with currency in place.



## SECTION 4 - HANDLING CASSETTES

---



*Figure 4-8. Installing the cassette into the dispensing mechanism.*

Compliments of: [www.atndepot.com](http://www.atndepot.com)

**For Sales & Service Call: 888-501-5246**

**Compliments of: [www.atmdepot.com](http://www.atmdepot.com)**

**SECTION 5**  
**MANAGEMENT FUNCTIONS**

**Compl i ments of: [www. atndepot. com](http://www.atndepot.com)**

## SECTION 5 - MANAGEMENT FUNCTIONS

---

### INTRODUCTION

This section describes the MANAGEMENT FUNCTIONS available for controlling the Cash Dispenser. When the CUSTOMER WELCOME screen is displayed, you can access the MANAGEMENT FUNCTIONS menu by following the procedure described next.

### ACCESSING THE MANAGEMENT FUNCTIONS MENU

- 1.) Press and hold down the <BLUE> key; while holding down the <BLUE> key, press the <1> key. Release both keys. After a moment the Top Menu will be displayed.
- 2.) At the Top Menu (see figure below), select MANAGEMENT FUNCTIONS.

*The TOP MENU Screen.*



- 3.) Enter the MASTER or ADMINISTRATION password at the Password Entry display (see figure below). The factory default MASTER PASSWORD is '123456'. The factory default ADMINISTRATION PASSWORD is '987654'.

*The PASSWORD entry screen.*

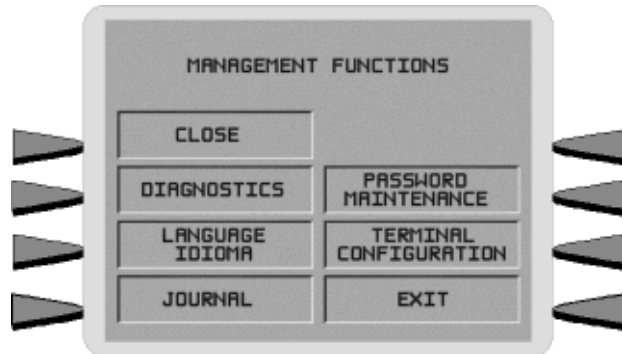


When a valid password is entered, the MANAGEMENT FUNCTIONS menu (see the figure on the next page) will be displayed. Once you have entered the MANAGEMENT FUNCTIONS Menu you may perform any of the functions allowed by the type of password used.

---

## SECTION 5 - MANAGEMENT FUNCTIONS

The MANAGEMENT FUNCTIONS Screen.



The ADMINISTRATION password allows access to a limited group of functions such as CLOSE, DIAGNOSTICS, etc. The MASTER PASSWORD allows access to all functions performed with the ADMINISTRATION password plus access to the Cash Dispenser configuration functions.

Each MANAGEMENT FUNCTION description will include the function name, instructions for accessing the function, a factory default value (if applicable) and any error conditions associated with the use of the function.

### FUNCTION AVAILABILITY

Some function screens or options described on the following pages may be present but not accessible on your Cash Dispenser. In these cases when you attempt to access the function you will receive a message informing you that the feature or hardware required to support it is not available.

In other cases a function screen or option described here may not even be present in the Management Functions for your particular Cash Dispenser. In such cases this is because the function is not available in the version of terminal operating software currently loaded in the unit.

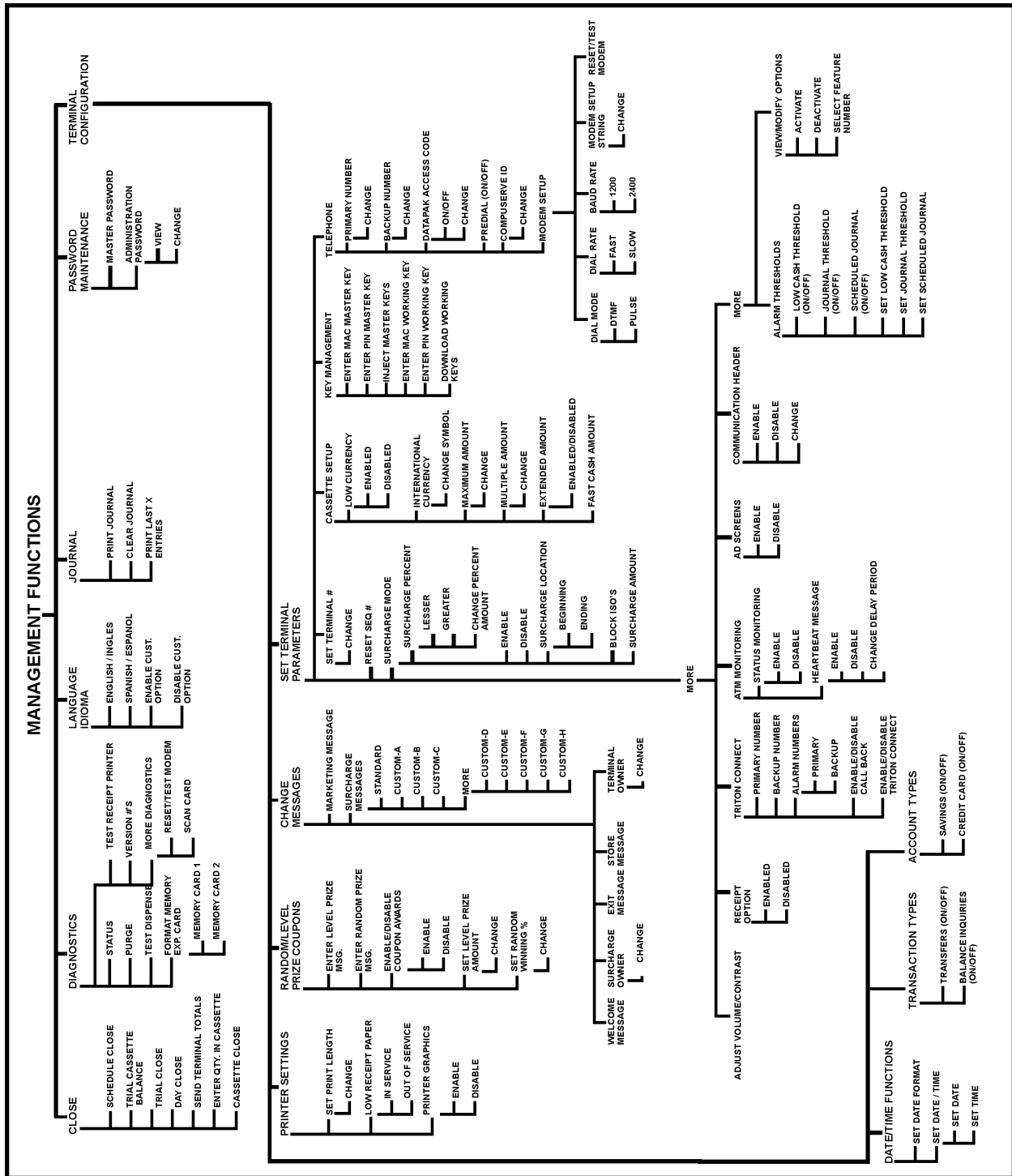
You may also notice that the factory default values for some functions on your terminal may differ from the values shown in this manual. Again, this is because versions of the terminal operating software customized for a particular processor may require non-standard default values for some parameters.

### MANAGEMENT FUNCTIONS CHART

The chart on the next page shows the organization of the various Management Functions. You can use this chart to quickly navigate to a particular function, or simply to see how functions are grouped and related together at different “levels” of the menu structure.

Compliments of: [www.atmdepot.com](http://www.atmdepot.com)

# SECTION 5 - MANAGEMENT FUNCTIONS



Management Functions Chart

Compliments of: [www.atndepot.com](http://www.atndepot.com)

## SECTION 5 - MANAGEMENT FUNCTIONS

**FUNCTION: MANAGEMENT FUNCTIONS**

**FACTORY DEFAULT: N/A**

**ACCESS INSTRUCTIONS:**

Select the MANAGEMENT FUNCTIONS option from the Top Menu (see page 5-2 for instructions on how to access the Top menu).

**DESCRIPTION:**

The MANAGEMENT FUNCTIONS menu allows the terminal operator to access the following functions:

- 1.) CLOSE
- 2.) DIAGNOSTICS
- 3.) LANGUAGE/IDIOMA
- 4.) JOURNAL
- 5.) PASSWORD MAINTENANCE
- 6.) TERMINAL CONFIGURATION

**ERROR CONDITIONS:**

There are no error conditions directly associated with this function.

Compliments of: [www.atndepot.com](http://www.atndepot.com)

## SECTION 5 - MANAGEMENT FUNCTIONS

**FUNCTION: CLOSE**

**FACTORY DEFAULT: N/A**

**ACCESS INSTRUCTIONS:**

Select the CLOSE option from the MANAGEMENT FUNCTIONS screen to view the options available from the SELECT CLOSE FUNCTION menu.

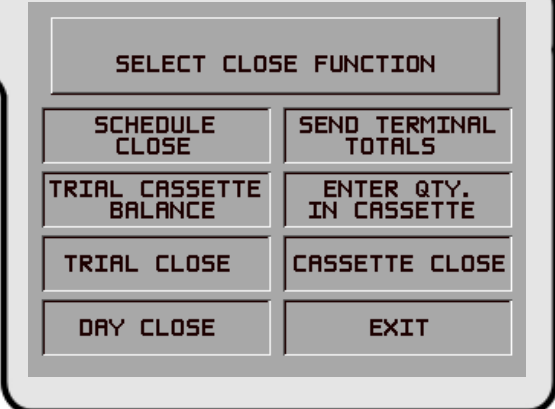
**DESCRIPTION:**

The SELECT CLOSE FUNCTION menu allows the terminal operator to perform the following functions:

- 1.) SCHEDULE CLOSE
- 2.) TRIAL CASSETTE BALANCE
- 3.) TRIAL CLOSE
- 4.) DAY CLOSE
- 5.) SEND TERMINAL TOTALS
- 6.) ENTER QTY. IN CASSETTE
- 7.) CASSETTE CLOSE

**ERROR CONDITIONS:**

There are no error conditions directly associated with this function.





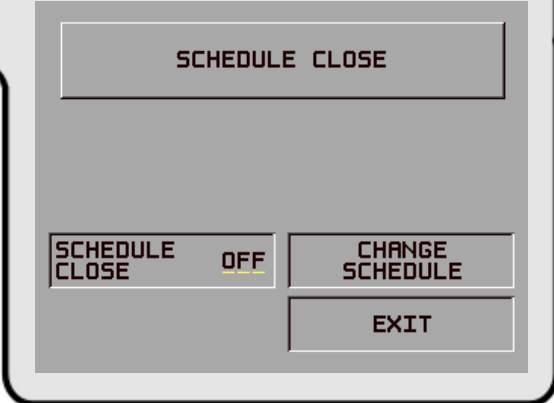
## SECTION 5 - MANAGEMENT FUNCTIONS

**FUNCTION: SCHEDULE CLOSE**

**FACTORY DEFAULT: OFF**

**ACCESS INSTRUCTIONS:**

- 1.) Select CLOSE from the MANAGEMENT FUNCTION screen.
- 2.) Select SCHEDULE CLOSE.



**DESCRIPTION:**

This function allows you to turn on or off the SCHEDULE CLOSE feature. It also provides access to the CHANGE SCHEDULE function, which allows you to specify the time of day when a CLOSE process will be automatically initiated (if the SCHEDULE CLOSE feature is turned ON). When the feature is turned OFF, the close procedure must be initiated manually.

The current state of the SCHEDULE CLOSE feature is shown as either ON or OFF in the label on the left-hand side of the display. Press the button next to this label to toggle the state of the feature between ON and OFF.

**NOTE:** The close information will be written to the Electronic Journal, allowing it to be printed out, or retrieved by a remote computer equipped with Triton Connect software (version 3.0 or later). Day Close reports initiated by this function will not be printed by the receipt printer.

**ERROR CONDITIONS:**

There are no error conditions directly associated with this function.

Compliments of: [www.atndepot.com](http://www.atndepot.com)

## SECTION 5 - MANAGEMENT FUNCTIONS

### FUNCTION: CHANGE SCHEDULE

**FACTORY DEFAULT: N/A**

#### ACCESS INSTRUCTIONS:

- 1.) Select CLOSE from the MANAGEMENT FUNCTION screen.
- 2.) Select SCHEDULE CLOSE.
- 3.) Select CHANGE SCHEDULE.

#### DESCRIPTION:

This function is used to set the time, in hours and minutes, at which the terminal will automatically initiate contact with the processor and perform a close operation. The time is entered in the form 'HH:MM:SS' (hours, minutes, seconds). Do not enter the ':' characters separating the fields, just the fields themselves. Press CLEAR to erase everything and start over. Press the BACKSPACE key to back up and erase a single character. Press QUIT to escape without doing anything. Press SET TIME to load the entered time into the clock.

The Cash Dispenser will not let you enter an invalid number for hours or minutes. The clock will properly handle the rollover to the year 2000.

#### ERROR CONDITIONS:

There are no error conditions directly associated with this function.

SET DAY CLOSE TIME  
DAY CLOSE TIME=  
PRESS 2 FOR AM OR 7 FOR PM

BACKSPACE-->

HH:MM:SS XM

CLEAR-->

QUIT-->

SET TIME-->

## SECTION 5 - MANAGEMENT FUNCTIONS

**FUNCTION: TRIAL CASSETTE BALANCE**

**FACTORY DEFAULT: N/A**

**ACCESS INSTRUCTIONS:**

- 1.) Select CLOSE from the MANAGEMENT FUNCTION screen.
- 2.) Select TRIAL CASSETTE BALANCE.

**DESCRIPTION:**

Selecting this function prints a receipt summarizing activity on the cassette since the last CASSETTE CLOSE was performed. The totals are not cleared (set to zero) or reported to the host during a trial cassette close.

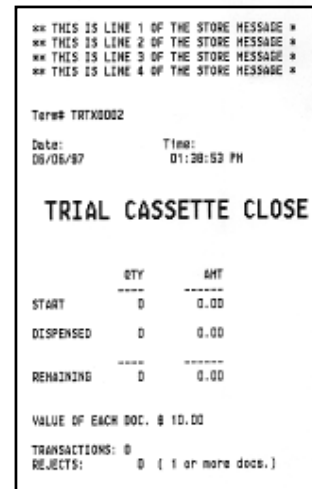
The following information is provided:

- 1.) START. Includes the starting quantity of notes in the cassette, and the total value of this quantity.
- 2.) DISPENSED. Shows the number of notes that have been dispensed and the value of this quantity of notes.
- 3.) REMAINING. Shows the number of notes remaining in the cassette, and the total value of these notes.
- 4.) VALUE OF EACH DOC. The denomination of the notes in the cassette.
- 5.) TRANSACTIONS. The number of transactions that have occurred since the last.
- 6.) REJECTS. The number of reject events. Rejects can involve more than a single note per event.

**ERROR CONDITIONS:**

There are no error conditions directly associated with this function.

SELECT CLOSE FUNCTION	
SCHEDULE CLOSE	SEND TERMINAL TOTALS
TRIAL CASSETTE BALANCE	ENTER QTY. IN CASSETTE
TRIAL CLOSE	CASSETTE CLOSE
DRY CLOSE	EXIT



Sample TRIAL CASSETTE CLOSE receipt.

Compliments of: [www.atmdepot.com](http://www.atmdepot.com)

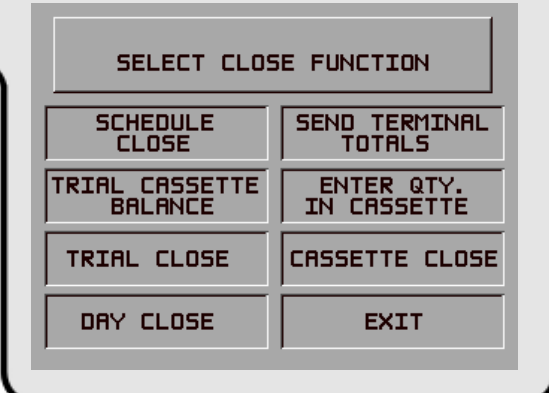
## SECTION 5 - MANAGEMENT FUNCTIONS

**FUNCTION: TRIAL CLOSE**

**FACTORY DEFAULT: N/A**

**ACCESS INSTRUCTIONS:**

- 1.) Select CLOSE from the MANAGEMENT FUNCTIONS screen.
- 2.) Select TRIAL CLOSE.



**DESCRIPTION:**

The TRIAL CLOSE function is used during the daily close procedure. It does the same thing as DAY CLOSE, except that the totals are not cleared.

The report printed by the TRIAL CLOSE is used to balance your Cash Dispenser before you actually balance with your processor. It contains information obtained from the processor and information that is obtained from the terminal itself.

Typically, you would do a TRIAL CLOSE to get the totals from the Cash Dispenser.

The report shows the total number of customer transactions (Withdrawals, Inquiries and Transfers) recorded by the host processor and the terminal since the last Day Close was performed. The two-column format allows the host and terminal totals in each category to be easily compared. The 'Settlement \$' value is the host processor's record of the total currency dispensed from the terminal since the last Day Close was performed.

```

** THIS IS LINE 1 OF THE STORE MESSAGE *
** THIS IS LINE 2 OF THE STORE MESSAGE *
** THIS IS LINE 3 OF THE STORE MESSAGE *
** THIS IS LINE 4 OF THE STORE MESSAGE *

Term# 123456
Date: 07/01/97      Time: 04:53:15 PM

      TRIAL DAY CLOSE
***HOST TOTALS NOT RECEIVED***
      HOST   TERMINAL
-----
Withdrawals      0
Inquiries        0
Transfers        0
SETTLEMENT $    0.00
    
```

*Sample TRIAL DAY CLOSE receipt.*

**ERROR CONDITIONS:**

A call to the processor host computer is required to complete the operation. If the call to the host is not completed successfully, a warning (\*\*HOST TOTALS NOT RECEIVED\*\*) will be printed on the report.

Compliments of: [www.atmdepot.com](http://www.atmdepot.com)

# SECTION 5 - MANAGEMENT FUNCTIONS

**FUNCTION: DAY CLOSE**

**FACTORY DEFAULT: N/A**

**ACCESS INSTRUCTIONS:**

- 1.) Select CLOSE from the MANAGEMENT FUNCTIONS screen.
- 2.) Select DAY CLOSE.

SELECT CLOSE FUNCTION

SCHEDULE CLOSE	SEND TERMINAL TOTALS
TRIAL CASSETTE BALANCE	ENTER QTY. IN CASSETTE
TRIAL CLOSE	CASSETTE CLOSE
DAY CLOSE	EXIT

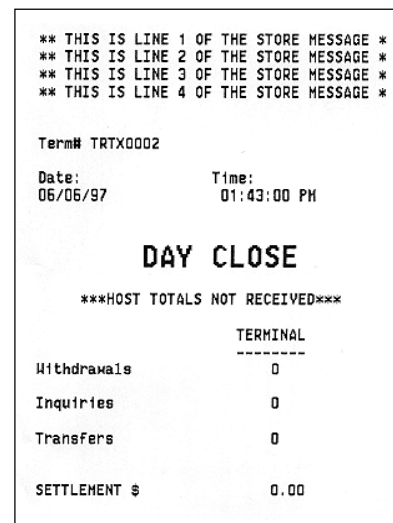
**DESCRIPTION:**

The DAY CLOSE Function is used to complete daily balancing of the Cash Dispenser with the processor. The DAY CLOSE is performed to clear the totals and switch to the next business day. This function prints a report summarizing all of the activity done by the Cash Dispenser since the last DAY CLOSE was completed. The information includes a total of all transactions.

This function also calls your host processor's computer and commands it to download the totals it has accumulated for the current business day.

The DAY CLOSE is normally completed as the final step in the daily balancing process. The DAY CLOSE report is printed to the receipt printer. The TRIAL CLOSE function does the same thing as the DAY CLOSE, except that the totals are not cleared. See the TRIAL CLOSE function for more information.

**NOTE: If the DAY CLOSE is not performed at the same time as the processors' day close, the host and terminal totals may not match.**



*Sample DAY CLOSE receipt.*

**ERROR CONDITIONS:**

A call to the processor host computer is required to complete the operation. If the call to the host is not completed successfully, a warning (\*\*HOST TOTALS NOT RECEIVED\*\*) will be printed on the report.

Compliments of: [www.atmdepot.com](http://www.atmdepot.com)

## SECTION 5 - MANAGEMENT FUNCTIONS

**FUNCTION: SEND TERMINAL TOTALS**

**FACTORY DEFAULT: OFF**

**ACCESS INSTRUCTIONS:**

- 1.) Select CLOSE from the MANAGEMENT FUNCTION screen.
- 2.) Select SEND TERMINAL TOTALS.

**DESCRIPTION:**

This function allows you to turn on or off the REPORT TERMINAL TOTALS feature. When the feature is turned ON, the terminal will send accumulated totals information to the processor during the close operation. Terminal totals include the total value of all withdrawal, inquiry and transfer transactions that have occurred since the last close operation (see the description of the DAY CLOSE function for additional information).

The current state of the SEND TERMINAL TOTALS feature is shown as either ON or OFF in the label on the left-hand side of the display. Press the button next to this label to toggle the state of the feature between ON and OFF.

**ERROR CONDITIONS:**

There are no error conditions directly associated with this function.

**REPORT TERMINAL TOTALS**

WHEN THIS FUNCTION IS ON THE  
TERMINAL TOTALS WILL BE  
SENT TO THE HOST DURING A  
CLOSE PROCEDURE.

REPORT  
TOTALS

OFF

EXIT

## SECTION 5 - MANAGEMENT FUNCTIONS

### FUNCTION: ENTER QTY. IN CASSETTE

**FACTORY DEFAULT:** '0'

**ACCESS INSTRUCTIONS:**

- 1.) Select CLOSE from the MANAGEMENT FUNCTION screen.
- 2.) Select ENTER QTY. IN CASSETTE.

ENTER THE NUMBER OF BILLS  
THAT ARE IN THE CASSETTE NOW  
(NOT THE VALUE)

-----  
AND THEN PRESS 'OK'

**DESCRIPTION:**

The ENTER QTY. IN CASSETTE function allows entry of the number of documents in the cassette. This number is used as a starting point for the cassette close report, the Dispense Counter value on the Receipt Printer Report and the Low Cash Threshold feature. Enter the total number of documents in the cassette and press <OK>.

**NOTE:** Enter the *number* of documents placed in a cassette, not the value of those documents.

**ERROR CONDITIONS:**

There are no error conditions directly associated with this function.

Compliments of: [www.atndepot.com](http://www.atndepot.com)

## SECTION 5 - MANAGEMENT FUNCTIONS

**FUNCTION: CASSETTE CLOSE**

**FACTORY DEFAULT: N/A**

**ACCESS INSTRUCTIONS:**

- 1.) Select CLOSE from the MANAGEMENT FUNCTION screen.
- 2.) Select CASSETTE CLOSE.

SELECT CLOSE FUNCTION

SCHEDULE CLOSE	SEND TERMINAL TOTALS
TRIAL CASSETTE BALANCE	ENTER QTY. IN CASSETTE
TRIAL CLOSE	CASSETTE CLOSE
DRY CLOSE	EXIT

**DESCRIPTION:**

The CASSETTE CLOSE function is used to complete the balancing of a specific currency cassette of the Cash Dispenser. This function prints a report summarizing all activity on the Cash Dispenser for the selected cassette since the last CASSETTE CLOSE was completed. The report includes a total of all transactions.

The CASSETTE CLOSE is normally completed as the final step in balancing the currency cassette before removing it to be replenished. The CASSETTE CLOSE report is printed to the Receipt Printer. Completing a CASSETTE CLOSE clears the cassette total from the Cash Dispenser.

**NOTE:** The Cassette Close operation also resets the number of bills loaded in the cassette to zero (0). After performing a cassette close, use the “ENTER QTY IN CASSETTE” function to enter the number of bills in the cassette.

**ERROR CONDITIONS:**

There are no error conditions directly associated with this function.



*Sample CASSETTE CLOSE receipt.*

Compliments of: [www.atmdepot.com](http://www.atmdepot.com)



## SECTION 5 - MANAGEMENT FUNCTIONS

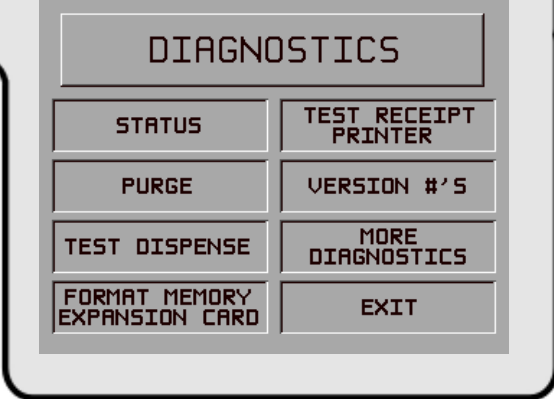
**FUNCTION: DIAGNOSTICS**

**FACTORY DEFAULT: N/A**

**ACCESS INSTRUCTIONS:**

Select DIAGNOSTICS from the MANAGEMENT FUNCTIONS screen.

**DESCRIPTION:**



DIAGNOSTICS	
STATUS	TEST RECEIPT PRINTER
PURGE	VERSION #'S
TEST DISPENSE	MORE DIAGNOSTICS
FORMAT MEMORY EXPANSION CARD	EXIT

Select one of the following to perform the appropriate DIAGNOSTICS test:

- Select STATUS to determine the operational status of the Cash Dispenser.
- Select PURGE to complete a PURGE cycle on the dispensing mechanism.
- Select TEST DISPENSE to perform a combined dispense and reject operation on the dispensing mechanism.
- Select FORMAT MEMORY EXPANSION CARD to erase the contents of a memory Expansion Card and to prepare the card to receive new data.
- Select the TEST RECEIPT PRINTER option to test the operation of the Receipt Printer.
- Select the VERSION #'S option to display a screen that provides version numbers for the various components of the terminal operating software.
- Select the MORE DIAGNOSTICS option to access the following diagnostic functions:
  - RESET/TEST MODEM. Select this option to verify that a modem is installed and that it is capable of being configured.
  - SCAN CARD. Select this option to verify that a customer's ATM or credit card can be read by the terminal card reader.

**NOTE:** The diagnostics options do not have a time-out associated with them. You must manually exit the diagnostics mode when you are finished.

**ERROR CONDITIONS:**

There are no error conditions directly associated with this function.

Compliments of: [www.atndepot.com](http://www.atndepot.com)

## SECTION 5 - MANAGEMENT FUNCTIONS

### FUNCTION: STATUS

**FACTORY DEFAULT: N/A**

#### ACCESS INSTRUCTIONS:

- 1.) Select DIAGNOSTICS from the MANAGEMENT FUNCTIONS screen.
- 2.) Select the STATUS option.

#### DESCRIPTION:

The STATUS command is used to check the status of four functional areas of the dispensing mechanism. These areas are the current Status of Count Sensors, the current Double Detect status, the current average thickness of the documents being dispensed, and the current average length of the documents being dispensed. Any of the following sets of return codes will indicate that all of the areas are operating normally:

- 1.) '40 50 40 36'
- 2.) '50 50 40 36'
- 3.) '44 50 40 36'
- 4.) '54 50 40 36'

The cancel button must be pressed to return to the diagnostic's menu.

#### ERROR CONDITIONS:

If any code other than what is indicated above is displayed contact your service provider for assistance.



RETURN CODE: 50 50 40 36

PRESS CANCEL TO CONTINUE

## SECTION 5 - MANAGEMENT FUNCTIONS

**FUNCTION: PURGE**

**FACTORY DEFAULT: N/A**

**ACCESS INSTRUCTIONS:**

- 1.) Select DIAGNOSTICS from the MANAGEMENT FUNCTIONS screen.
- 2.) Select the PURGE option.

**DESCRIPTION:**

The purge command instructs the dispenser to remove all documents from the feed path. When the purge command is used to clear the feed path following a jam or failure of the dispenser, some or all of the notes may pass out of the exit slot depending on their location and the fault condition. The return code for a successful Purge is '20 20 20'. Press the cancel key to return to the diagnostics menu.

**ERROR CONDITIONS:**

If any code other than '20, 20, 20' is displayed contact your service provider for assistance.

RETURN CODE: 20 20 20

---

PRESS CANCEL TO CONTINUE

Compliments of: [www.atndepot.com](http://www.atndepot.com)

## SECTION 5 - MANAGEMENT FUNCTIONS

### FUNCTION: TEST DISPENSE

**FACTORY DEFAULT: N/A**

**ACCESS INSTRUCTIONS:**

- 1.) Select DIAGNOSTICS from the MANAGEMENT FUNCTIONS screen.
- 2.) Select the TEST DISPENSE option.

**DESCRIPTION:**

This command instructs the dispensing mechanism to dispense one note from the cassette into the reject box. This test exercises the dispenser without sending notes out the exit. A return code of '20 20 21' indicates a successful test dispense. Press the cancel key to return to the diagnostics menu.

**ERROR CONDITIONS:**

If any code other than '20 20 21' is displayed contact your service provider for assistance.



RETURN CODE: 20 20 21

PRESS CANCEL TO CONTINUE

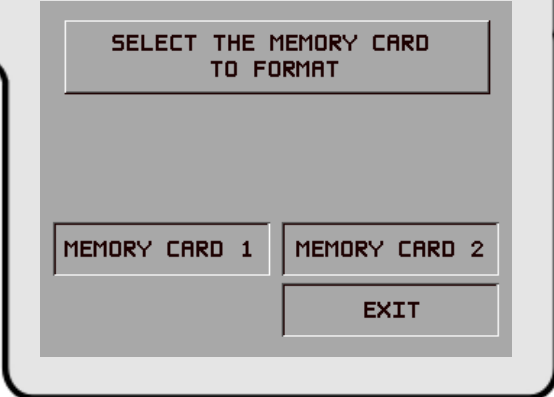
## SECTION 5 - MANAGEMENT FUNCTIONS

**FUNCTION: FORMAT MEMORY EXP. CARD**

**FACTORY DEFAULT: N/A**

**ACCESS INSTRUCTIONS:**

- 1.) Select DIAGNOSTICS from the MANAGEMENT FUNCTIONS screen.
- 2.) Select the FORMAT MEMORY EXPANSION CARD option.

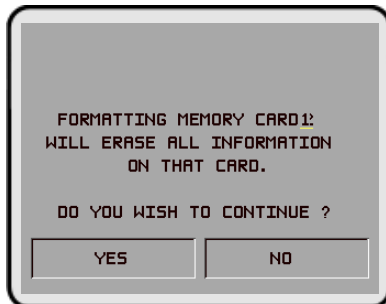


**DESCRIPTION:**

All Memory Expansion Cards are shipped from the factory formatted and ready to accept downloaded Ad Graphics files. Normally, it will only be necessary to format a memory Expansion card to erase the existing files, or in the event a file becomes corrupted. If it becomes necessary to format a Memory Expansion Card, it can be accomplished from either the local terminal or through commands downloaded from a Triton Connect Host Computer.

**CAUTION:** Formatting a Memory Expansion Card will erase all files stored on the card. Do not format a Memory Expansion Card unless you have the capability to download files to the terminal.

When the SELECT MEMORY CARD TO FORMAT screen is displayed, the options that are made available are MEMORY CARD 1 or MEMORY CARD 2. Selecting either will begin the formatting process.



**ERROR CONDITIONS:**

There are no error conditions directly associated with this function.

Compliments of: [www.atndepot.com](http://www.atndepot.com)

# SECTION 5 - MANAGEMENT FUNCTIONS

**FUNCTION: TEST RECEIPT PRINTER**

**FACTORY DEFAULT: N/A**

**ACCESS INSTRUCTIONS:**

- 1.) Select DIAGNOSTICS from the MANAGEMENT FUNCTIONS screen.
- 2.) Select the TEST RECEIPT PRINTER option.

RETURN CODE:     00    

---

PRESS CANCEL TO CONTINUE

**DESCRIPTION:**

This command will print two lines of text on the receipt printer and then advance and cut the paper. The text should be 42 characters wide. The remainder of the information on the TEST RECEIPT PRINTER print out is terminal configuration data. If the printer test fails to print two lines of 42 characters, fails to advance the paper, or fails to cut the paper, contact your service provider for assistance. A return code of '00' indicates a successful printer test. Press the cancel key to return to the DIAGNOSTICS main menu.

```

123456789012345678901234567890123456789012
123456789012345678901234567890123456789012

Date:           Time:
04/19/99        09:35:03 AM

Mode: Live

Terminal: 123456
Terminal Owner:

Epson Version:  S002.01840 04/13/99
Program Version: SA-9800.26 04/16/99
Table Version:  ST-9800.13 04/16/99

Printed date format: MDDYY
Language is ENGLISH

Quad serial board is not installed
EPRM does support quad serial board
LED sign is not installed

PIN Master Key Check Digits:  82E136
MAC Master Key Check Digits:  82E136
DATA Master Key is NOT loaded
PIN Working Key Check Digits:  008628
MAC Working Key Check Digits:  82E136
DATA Working Key is NOT loaded

Primary Phone Number:  1040000

Secondary Phone Number:
CompuServe Routing ID:
Touch Tone, 1200 Baud, Dial Rate: 70
7 data bits, even parity

Surcharging is disabled

Surcharge Owner:
Surcharge Amount:          1.00 x 0

Bill Size:                 10.00
Maximum Withdrawal Amount: 500.00
Cassette Low Checking is enabled
    
```

*Sample RECEIPT  
PRINTER test results.*

```

Fast Cash Amounts:
                                10.00
                                20.00
                                30.00
                                40.00
                                50.00

Prize Coupon printing is disabled
Level prize amount:          0.00
Random prize X: 0

Minimum lines per receipt: 35
CHECKING is spelled: CHECKING
Dispense Counter:          1176
Double Encryption is disabled
Optional Receipt Printing is disabled
Low paper checking is enabled
Bill size checking is enabled
Extended amount is disabled
Status monitoring is disabled
Heartbeat is disabled
AD screens are enabled
Receipt graphics are enabled
Day-first printed date is disabled
Latin-American style receipt is disabled
Scheduled day close is disabled
    
```

**ERROR CONDITIONS:**

If any code other than '00' is displayed contact your service provider for assistance.

## SECTION 5 - MANAGEMENT FUNCTIONS

**FUNCTION: VERSION #'S**

**FACTORY DEFAULT: N/A**

**ACCESS INSTRUCTIONS:**

- 1.) Select DIAGNOSTICS from the MANAGEMENT FUNCTIONS screen.
- 2.) Select the VERSION #'S option.

PRESS ANY KEY TO CONTINUE

Version	Date
EPROM PROGRAM TABLE	

**DESCRIPTION:**

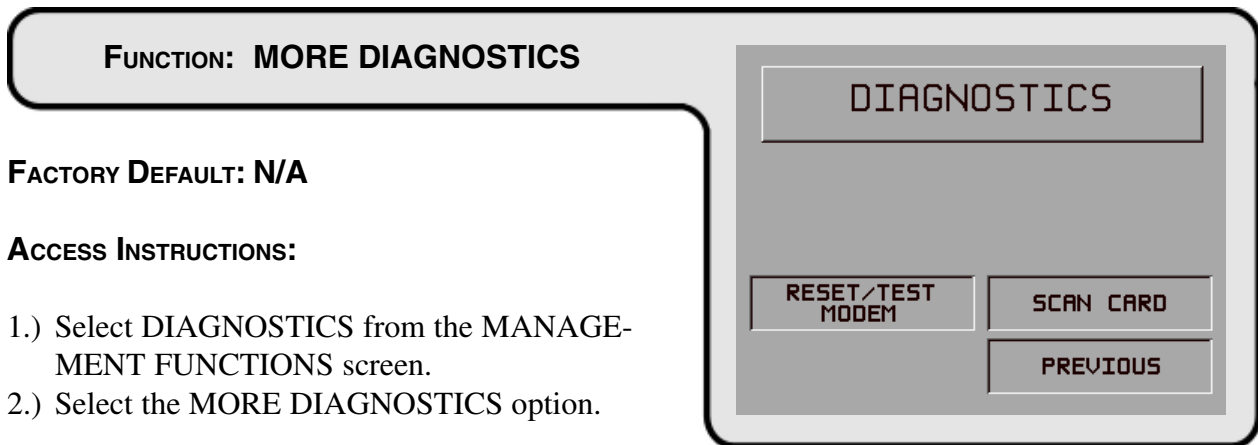
This function displays the version information for the terminal software that is running in the Cash Dispenser. Normally you do not need to access this function unless you are asked to by service personnel.

**ERROR CONDITIONS:**

There are no error conditions directly associated with this function.

Compliments of: [www.atndepot.com](http://www.atndepot.com)

## SECTION 5 - MANAGEMENT FUNCTIONS





## SECTION 5 - MANAGEMENT FUNCTIONS

**FUNCTION: RESET/TEST MODEM**

**FACTORY DEFAULT: N/A**

**ACCESS INSTRUCTIONS:**

- 1.) Select DIAGNOSTICS from the MANAGEMENT FUNCTIONS screen.
- 2.) Select MORE DIAGNOSTICS.
- 3.) Select the RESET/TEST MODEM option.

MODEM TESTING / INITIALIZATION

IN PROGRESS

PLEASE WAIT

**DESCRIPTION:**

This test confirms that the CPU Module can communicate with the modem and that the modem can be configured. This test does not test the ability of the modem to communicate on the phone line. If the RESET/TEST MODEM TEST fails, contact your service provider for assistance. Press the cancel key to return to the diagnostic's menu.

If the test is successful, the following message screen will be displayed:



**ERROR CONDITIONS:**

If the test fails, an error message will be displayed.

Compliments of: [www.atmdepot.com](http://www.atmdepot.com)

## SECTION 5 - MANAGEMENT FUNCTIONS

**FUNCTION: SCAN CARD**

**FACTORY DEFAULT: N/A**

**ACCESS INSTRUCTIONS:**

- 1.) Select DIAGNOSTICS from the MANAGEMENT FUNCTIONS screen.
- 2.) Select MORE DIAGNOSTICS.
- 3.) Select the SCAN CARD option.

PLEASE **INSERT** AND THEN REMOVE  
THE CARD TO BE SCANNED

EXIT

### DESCRIPTION:

The SCAN CARD function reads a card and displays the information imprinted on its magnetic strip. This can be done on a customer card that doesn’t seem to work in the Cash Dispenser. If the customer complains of card read errors, first make sure that he or she is inserting the card correctly. Then try to read the card with SCAN CARD. If the card can be read properly, the information from track 1 and track 2 will be displayed. A card need only have a readable track 2 to operate successfully in the Cash Dispenser.

A series of prompt screens direct the user to first INSERT the card to be scanned (shown above) and then to REMOVE it, after which the results of the scan are presented, as shown in the following:

PLEASE INSERT AND THEN **REMOVE**  
THE CARD TO BE SCANNED

TRACK 1:  
B000000000000000000000000000000000^  
  ^99121010000

TRACK 2:  
000000000000000000000000=912101000

EXIT

### ERROR CONDITIONS:

If the card is damaged or not a standard format, the screen will display an error message. If this happens, the card cannot be used for transactions on the Cash Dispenser.

Compliments of: [www.atndepot.com](http://www.atndepot.com)

## SECTION 5 - MANAGEMENT FUNCTIONS

**FUNCTION: LANGUAGE/IDIOMA**

**FACTORY DEFAULT: Country-specific**

**ACCESS INSTRUCTIONS:**

Select the LANGUAGE/IDIOMA option from the MANAGEMENT FUNCTIONS screen to view the additional options available.

**DESCRIPTION:**

This function provides access to the options that control the language that is displayed on the Cash Dispenser LCD Display. Current language options include English or Spanish (certain international versions of terminal software provide a French option instead of Spanish), and a customer option feature enables or disables customer-selection of the language in which text is presented on the LCD display.

- 1.) ENGLISH / INGLES
- 2.) SPANISH / ESPANOL
- 3.) ENABLE CUST. OPTION
- 4.) DISABLE CUST. OPTION

**ERROR CONDITIONS:**

There are no error conditions directly associated with this function.

DEFAULT LANGUAGE: **ENGLISH**

CUSTOMER SELECTED LANGUAGE

OPTION IS: **ENABLED**

ENGLISH INGLES	ENABLE CUST. OPTION
SPANISH ESPANOL	DISABLE CUST. OPTION
EXIT	

Compliments of: [www.atndepot.com](http://www.atndepot.com)

## SECTION 5 - MANAGEMENT FUNCTIONS

<p><b>FUNCTION:</b>    ENGLISH/INGLES</p> <p><b>FACTORY DEFAULT:</b> N/A</p> <p><b>ACCESS INSTRUCTIONS:</b></p> <ol style="list-style-type: none"> <li>1.) Select the LANGUAGE/IDIOMA option from the MANAGEMENT FUNCTIONS screen.</li> <li>2.) Select the ENGLISH/INGLES option.</li> </ol>	<p>DEFAULT LANGUAGE: <b>ENGLISH</b></p> <p>CUSTOMER SELECTED LANGUAGE</p> <p>OPTION IS: <b>ENABLED</b></p> <table border="1" style="margin: auto;"> <tr> <td>ENGLISH INGLES</td> <td>ENABLE CUST. OPTION</td> </tr> <tr> <td>SPANISH ESPAÑOL</td> <td>DISABLE CUST. OPTION</td> </tr> <tr> <td colspan="2" style="text-align: center;">EXIT</td> </tr> </table>	ENGLISH INGLES	ENABLE CUST. OPTION	SPANISH ESPAÑOL	DISABLE CUST. OPTION	EXIT	
ENGLISH INGLES	ENABLE CUST. OPTION						
SPANISH ESPAÑOL	DISABLE CUST. OPTION						
EXIT							

### DESCRIPTION:

Choosing this function when the DISABLE CUST. OPTION is selected will set the LCD screen to display only English text during a transaction.

Choosing this function when the ENABLE CUST. OPTION is selected will present customer transaction text in English initially, but will allow the customer to choose English or Spanish (or French for some versions of terminal software).

In addition to the customer transactions taking place in the English language, all Management Functions will be presented in English. All receipts will be printed in English text, as well.

### ERROR CONDITIONS:

There are no error conditions directly associated with this function.

Compliments of: [www.atmdepot.com](http://www.atmdepot.com)

## SECTION 5 - MANAGEMENT FUNCTIONS

**FUNCTION: SPANISH/ESPANOL**

**FACTORY DEFAULT: N/A**

**ACCESS INSTRUCTIONS:**

- 1.) Select the LANGUAGE/IDIOMA option from the MANAGEMENT FUNCTIONS screen.
- 2.) Select the SPANISH/ESPANOL option.

DEFAULT LANGUAGE: **SPANISH**

CUSTOMER SELECTED LANGUAGE

OPTION IS: **DISABLED**

ENGLISH INGLES	ENABLE CUST. OPTION
SPANISH ESPAÑOL	DISABLE CUST. OPTION
EXIT	

**DESCRIPTION:**

NOTE: Some versions of international software replace the Spanish language option with French.

Choosing this option when the DISABLE CUST. OPTION is selected will display only Spanish text during a transaction.

Choosing this option when the ENABLE CUST. OPTION is selected will give the customer the option of completing the transaction in either English or Spanish.

In addition to the transaction taking place in the Spanish language, all Management Functions will be presented in Spanish.

Some terminal software versions support the printing of receipts in Spanish.

**ERROR CONDITIONS:**

There are no error conditions directly associated with this function.

Compliments of: [www.atmdepot.com](http://www.atmdepot.com)

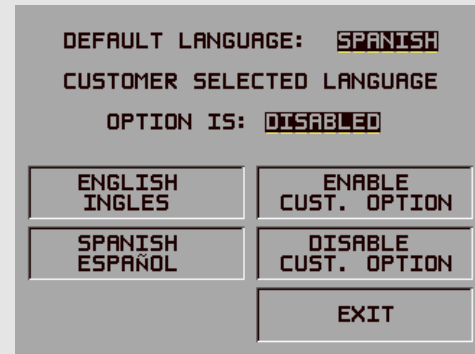
## SECTION 5 - MANAGEMENT FUNCTIONS

### FUNCTION: ENABLE/DISABLE CUST. OPTION

**FACTORY DEFAULT: 'OPTION IS: DISABLED'**

#### ACCESS INSTRUCTIONS:

- 1.) Select the LANGUAGE/IDIOMA option from the MANAGEMENT FUNCTIONS screen.
- 2.) Select either option, as appropriate:
  - ENABLE CUST. OPTION.
  - DISABLE CUST. OPTION.



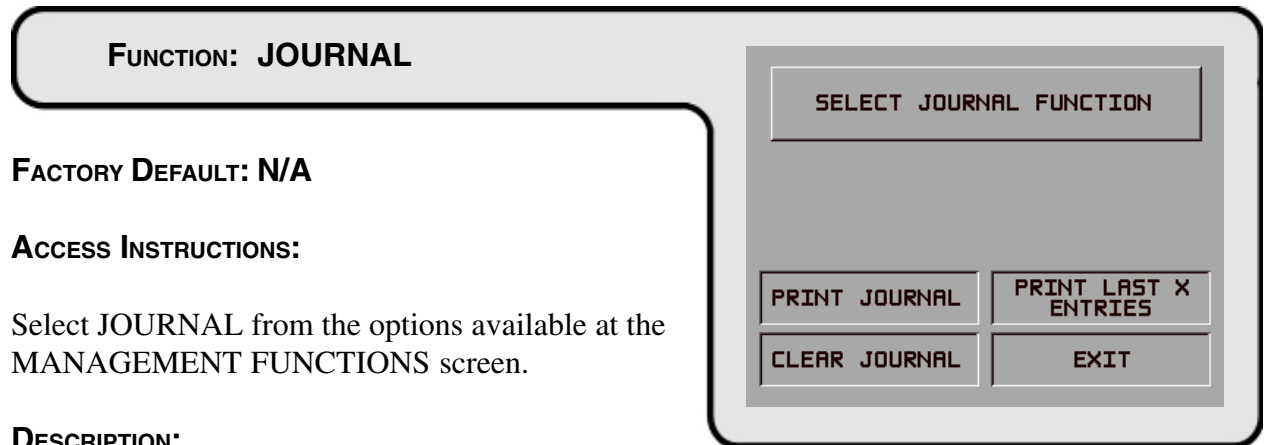
#### DESCRIPTION:

If the mode is ENABLED, the customer will be offered a bilingual screen instructing them to select a desired language (currently English and either Spanish or French depending upon software version) for the transaction. If the mode is DISABLED, the customer will not be offered this option.

#### ERROR CONDITIONS:

There are no error conditions directly associated with this function.

## SECTION 5 - MANAGEMENT FUNCTIONS



**FACTORY DEFAULT: N/A**

**ACCESS INSTRUCTIONS:**

Select JOURNAL from the options available at the MANAGEMENT FUNCTIONS screen.

**DESCRIPTION:**

Select the JOURNAL function from the MANAGEMENT FUNCTIONS screen to:

- 1.) PRINT THE JOURNAL
- 2.) CLEAR JOURNAL
- 3.) PRINT THE LAST X ENTRIES

**ERROR CONDITIONS:**

There are no error conditions directly associated with this function.

Compliments of: [www.atndepot.com](http://www.atndepot.com)

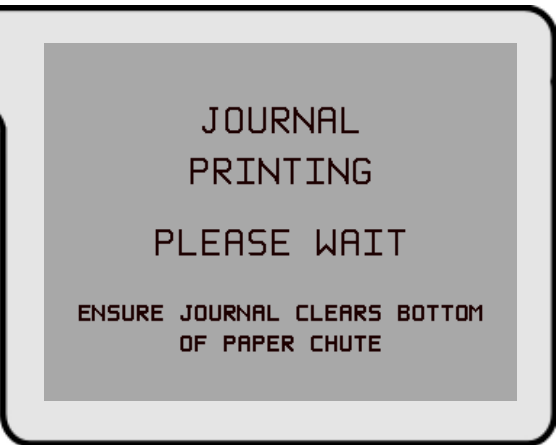
## SECTION 5 - MANAGEMENT FUNCTIONS

### FUNCTION: PRINT JOURNAL

**FACTORY DEFAULT: N/A**

**ACCESS INSTRUCTIONS:**

- 1.) Select JOURNAL from the options available at the MANAGEMENT FUNCTIONS screen.
- 2.) Select the PRINT JOURNAL option to print all unaudited records stored in the Electronic Journal.



JOURNAL  
PRINTING  
PLEASE WAIT  
ENSURE JOURNAL CLEARS BOTTOM  
OF PAPER CHUTE

**DESCRIPTION:**

The PRINT JOURNAL command is used to automatically print out any journal entries collected since the last time the journal was printed. ALL journal records will be printed, whether there are 1 or 2045 records. This command should be used regularly to print the audit trail of the terminal. This information should be maintained in case of an inquiry by a customer, and can also be useful in certain troubleshooting situations.

When this command is run, all unaudited records in the Electronic Journal are immediately sent to the receipt printer, and subsequently marked as audited. Any record printed in this fashion will not be printed again by this command, although it can be printed using the PRINT LAST X ENTRIES command. When the journal has finished printing, the SELECT JOURNAL FUNCTION screen will be displayed.

**ERROR CONDITIONS:**

If the operation fails, an error message will be displayed.



## SECTION 5 - MANAGEMENT FUNCTIONS

**FUNCTION: CLEAR JOURNAL**

**FACTORY DEFAULT: N/A**

**ACCESS INSTRUCTIONS:**

- 1.) Select JOURNAL from the options available at the MANAGEMENT FUNCTIONS screen.
- 2.) Select the CLEAR JOURNAL option to mark all journal entries stored in the Electronic Journal since the last time the CLEAR JOURNAL or PRINT JOURNAL functions were completed.

CLEARING  
JOURNAL

ALL RECORDS WILL BE MARKED  
AS AUDITED

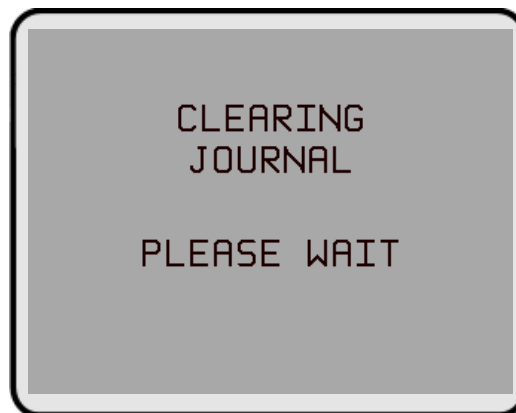
DO YOU WISH TO CONTINUE?

NO, CANCEL

YES, CLEAR

**DESCRIPTION:**

The CLEAR JOURNAL command is used to mark all unprinted records in the journal as ‘audited’. This means that they will not be printed out the next time a PRINT JOURNAL command is performed. Audited records are not erased. They are marked as if they had been printed. When this function is selected, a confirmation screen prompts the user to answer YES, CLEAR to continue with operation or NO, CANCEL to quit. If the user answers YES, CLEAR, the following screen will be displayed:



When the journal has been cleared, the SELECT JOURNAL FUNCTION screen will be displayed. Note that even after this command has been completed, records are still available for printing by using the PRINT LAST X ENTRIES command.

**ERROR CONDITIONS:**

If the operation fails, and error message will be displayed.

Compliments of: [www.atndepot.com](http://www.atndepot.com)

## SECTION 5 - MANAGEMENT FUNCTIONS

### FUNCTION: PRINT LAST X ENTRIES

**FACTORY DEFAULT: N/A**

#### ACCESS INSTRUCTIONS:

- 1.) Select JOURNAL from the options available at the MANAGEMENT FUNCTIONS screen.
- 2.) Select the PRINT LAST X ENTRIES option to print the last X (where 'X' is a number from 1 to 2045) entries stored in the Electronic Journal.

ENTER THE NUMBER OF RECORDS

TO PRINT

-----  
AND THEN PRESS 'OK'

#### DESCRIPTION:

This command is used to reprint records from the Electronic Journal, either before or after they have been audited using the CLEAR JOURNAL or PRINT JOURNAL commands. Records printed out using this command are not marked in any way. This command will not affect the operation of the PRINT JOURNAL command.

This command is used for several purposes. It can be used to reprint records for which the paper trail has been lost or destroyed. It can also be used to print out records before they are audited, for diagnostic purposes.

When using this command, the user is prompted to enter the number of the most recently collected records to be printed. It always operates on the last 'X' entries. If an operator needs to see a transaction that happened about 10 records earlier, entering '13' at the prompt will cause the last 13 records to be printed, but not cleared, from the buffer. This will ensure that the transaction in question is printed.

Subsequent uses of this command are not cumulative. No pointer is maintained that 'moves' each time this command is run. It always operates on the LAST X ENTRIES.

#### ERROR CONDITIONS:

Entering a number greater than the number of records in the buffer memory of the journal will cause all records to be printed. The buffer memory can contain up to 2045 records at any one time.

## SECTION 5 - MANAGEMENT FUNCTIONS

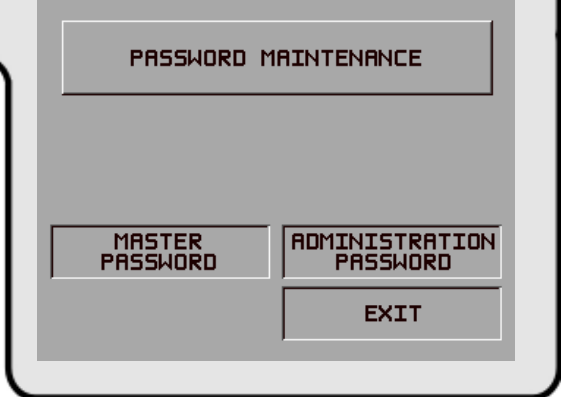
**FUNCTION: PASSWORD MAINTENANCE**

**FACTORY DEFAULT: N/A**

**ACCESS INSTRUCTIONS:**

Select the PASSWORD MAINTENANCE option from the MANAGEMENT FUNCTIONS screen.

**DESCRIPTION:**



The screenshot shows a screen with a title bar 'PASSWORD MAINTENANCE'. Below the title bar, there are three buttons: 'MASTER PASSWORD' on the left, 'ADMINISTRATION PASSWORD' on the right, and 'EXIT' centered below the other two.

The PASSWORD MAINTENANCE Function of MANAGEMENT FUNCTIONS menu allows access to menus for viewing and changing the following:

- 1.) MASTER PASSWORD
- 2.) ADMINISTRATION PASSWORD

**ERROR CONDITIONS:**

There are no error conditions directly associated with this function.

Compliments of: [www.atndepot.com](http://www.atndepot.com)

## SECTION 5 - MANAGEMENT FUNCTIONS

### FUNCTION: MASTER PASSWORD

**FACTORY DEFAULT: '123456'**

#### ACCESS INSTRUCTIONS:

- 1.) Select the PASSWORD MAINTENANCE option from the MANAGEMENT FUNCTIONS screen.
- 2.) Select the MASTER PASSWORD option.



#### DESCRIPTION:

The MASTER PASSWORD is the highest level password on the Cash Dispenser. It allows access to all functions except downloading of new software. The MASTER PASSWORD must be entered in order to change the ADMINISTRATION password. The factory default MASTER PASSWORD is '123456' and should be changed when the Cash Dispenser is installed.

To change the MASTER PASSWORD, select this function. You will be prompted to enter your new password. An asterisk (\*) will be displayed in place of the actual digits entered; therefore, you must enter the password a second time when prompted to confirm it.

The password can be from 4 to 12 digits long and can contain only numbers; letters are not allowed.

#### ERROR CONDITIONS:

A number of feedback screens may appear during password entry. These screens can appear if the second password entry did not match the first, you entered an invalid password, or the password you entered was too short (less than 4 characters).


## SECTION 5 - MANAGEMENT FUNCTIONS

**FUNCTION: ADMINISTRATION PASSWORD**

**FACTORY DEFAULT: '987654'**

**ACCESS INSTRUCTIONS:**

- 1.) Select the PASSWORD MAINTENANCE option from the MANAGEMENT FUNCTIONS screen.
- 2.) Select the ADMINISTRATION PASSWORD option.



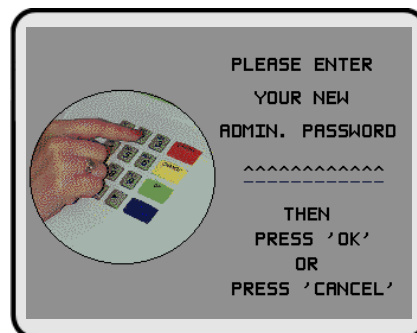
**DESCRIPTION:**

The ADMINISTRATION PASSWORD is used to perform daily management functions. This password DOES NOT allow access to the TERMINAL CONFIGURATION menu.

This password can only be changed when the MASTER PASSWORD is used to enter the MANAGEMENT FUNCTIONS area. Use the options provided to VIEW or CHANGE the password, as shown in the figures below. When the VIEW option is selected, the current password will be displayed for a few seconds. When changing the password, it must be entered twice, because the characters entered are not displayed (an asterisk (\*) is displayed in place of each character, for security reasons). The password length can range from 4 to 12 characters.



VIEW



CHANGE

**ERROR CONDITIONS:**

A number of feedback screens may appear during password entry. These screens can appear if the second password entry did not match the first, you entered an invalid password, or the password you entered was too short (less than 4 characters).

Compliments of: [www.atmdepot.com](http://www.atmdepot.com)

## SECTION 5 - MANAGEMENT FUNCTIONS

**FUNCTION: TERMINAL CONFIGURATION**

**FACTORY DEFAULT: N/A**

**ACCESS INSTRUCTIONS:**

Select the **TERMINAL CONFIGURATION** option from the **MANAGEMENT FUNCTIONS** screen.

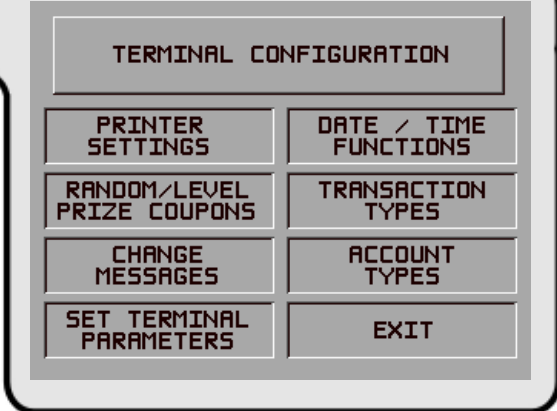
**DESCRIPTION:**

The **TERMINAL CONFIGURATION** option provides access to functions that allow the following parameters to be viewed and changed:

- 1.) PRINTER SETTINGS
- 2.) RANDOM/LEVEL PRIZE COUPONS
- 3.) CHANGE MESSAGES
- 4.) SET TERMINAL PARAMETERS
- 5.) DATE / TIME FUNCTIONS
- 6.) TRANSACTION TYPES
- 7.) ACCOUNT TYPES

**ERROR CONDITIONS:**

There are no error conditions directly associated with this function.



## SECTION 5 - MANAGEMENT FUNCTIONS

**FUNCTION: PRINTER SETTINGS**

**FACTORY DEFAULT: N/A**

**ACCESS INSTRUCTIONS:**

- 1.) Select the **TERMINAL CONFIGURATION** option from the **MANAGEMENT FUNCTIONS** screen.
- 2.) Select the **PRINTER SETTINGS** option.

PRINTER SETTINGS

SET PRINT LENGTH

PRINTER GRAPHICS

LOW RECEIPT PAPER

EXIT

**DESCRIPTION:**

This menu provides access to the following functions:

- 1.) SET PRINT LENGTH
- 2.) LOW RECEIPT PAPER
- 3.) PRINTER GRAPHICS

**ERROR CONDITIONS:**

There are no error conditions directly associated with this function.

Compliments of: [www.atndepot.com](http://www.atndepot.com)

## SECTION 5 - MANAGEMENT FUNCTIONS

**FUNCTION: SET PRINT LENGTH**

**FACTORY DEFAULT: '35'**

**ACCESS INSTRUCTIONS:**

- 1.) Select the **TERMINAL CONFIGURATION** option from the **MANAGEMENT FUNCTIONS** screen.
- 2.) Select the **PRINTER SETTINGS** option.
- 3.) Select **SET PRINT LENGTH**.

**DESCRIPTION:**

This function sets the minimum length of the receipt provided to the customer after each transaction.

**ERROR CONDITIONS:**

Changing the Print Length to less than 35 lines will prevent the receipt from exiting the front of the Cash Dispenser. This may cause paper jams that could result in printer damage.

MINIMUM PRINT LENGTH:       
(NUMBER OF LINES PER RECEIPT)

ENTER MIN. # LINES (0-99)

CHANGE

EXIT



## SECTION 5 - MANAGEMENT FUNCTIONS

**FUNCTION: LOW RECEIPT PAPER**

**FACTORY DEFAULT: 'OUT OF SERVICE'**

**ACCESS INSTRUCTIONS:**

- 1.) Select **TERMINAL CONFIGURATION** from the **MANAGEMENT FUNCTIONS** menu.
- 2.) Select the **PRINTER SETTINGS** option.
- 3.) Choose the **LOW RECEIPT PAPER** option.

WHEN RECEIPT PAPER BECOMES LOW, THE ATM WILL BE:  
**OUT OF SERVICE**

IN SERVICE	OUT OF SERVICE
EXIT	

**DESCRIPTION:**

After selecting the **LOW RECEIPT PAPER ON/OFF** option, a screen displaying, " WHEN RECEIPT PAPER BECOMES LOW, THE ATM WILL BE OUT OF SERVICE" (or **IN SERVICE** depending on terminal setup). Change to **IN SERVICE** or **OUT OF SERVICE** by pressing the Screen Key next to the appropriate text and pressing the **EXIT** key.

Selecting the **IN SERVICE** options will allow the terminal to continue to operate after it senses a Receipt Printer Paper Low condition (Error Code 183). *Selecting this option will allow the terminal to operate with low or no receipt paper in the terminal.*

Selecting the **OUT OF SERVICE** option will allow the terminal to report a Receipt Printer Paper Low condition (Error Code 183), and will place the terminal in an **OUT OF SERVICE** condition until the receipt paper is replenished.

**ERROR CONDITIONS:**

**Error Code 183 – Receipt Printer Paper Low** will take the terminal **OUT OF SERVICE**. To restore the terminal to normal operation the paper must be replenished and the **Reset Error** button pressed after the terminal has been reset and is displaying the **OUT OF SERVICE** screen.

Compliments of: [www.atmdepot.com](http://www.atmdepot.com)

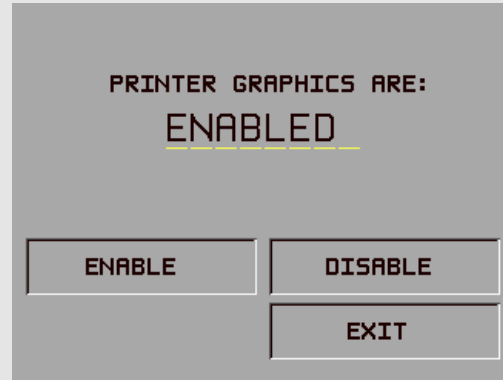
## SECTION 5 - MANAGEMENT FUNCTIONS

### FUNCTION: PRINTER GRAPHICS

**FACTORY DEFAULT: ENABLED**

#### ACCESS INSTRUCTIONS:

- 1.) Select **TERMINAL CONFIGURATION** option from the **MANAGEMENT FUNCTIONS** screen.
- 2.) Select the **PRINTER SETTINGS** option.
- 3.) Select **PRINTER GRAPHICS**.



#### DESCRIPTION:

The Printed Graphics feature can only be used when an optional Memory Expansion Card is installed in the terminal. Triton Connect Software Release 1.8 (or above) allows bit mapped graphics (in '.bmp' format) to be downloaded to the terminal. This graphic will be printed on the receipt when the **PRINTER GRAPHICS** option has been **ENABLED**. This feature cannot be supported without the addition of an Expansion Memory Card.

To turn on the **PRINTER GRAPHICS** feature, choose the **ENABLE** option on this screen. To inhibit the **PRINTER GRAPHICS** feature, press the **DISABLE** key.

#### ERROR CONDITIONS:

If **PRINTER GRAPHICS** is enabled and there are no graphic images loaded into the Expansion Memory Card, the receipt printer will print normal receipts without graphics. There are no error conditions associated with this function.

## SECTION 5 - MANAGEMENT FUNCTIONS

**FUNCTION: RANDOM/LEVEL PRIZE COUPONS**

**FACTORY DEFAULT: N/A**

**ACCESS INSTRUCTIONS:**

- 1.) Select **TERMINAL CONFIGURATION** from the **MANAGEMENT FUNCTIONS** menu.
- 2.) Select **RANDOM/LEVEL PRIZE COUPONS** from the **TERMINAL CONFIGURATION** menu.

PRIZE COUPON CONFIGURATION

ENTER LEVEL PRIZE MSG.	SET LEVEL PRIZE AMOUNT
ENTER RANDOM PRIZE MSG.	SET RANDOM WINNING %
ENABLE/DISABLE COUPON AWARDS	EXIT

**DESCRIPTION:**

This function provides access to the following options, which will set up terminal operations for issuing printed and dispensed prize coupons:

- 1.) ENTER LEVEL PRIZE MESSAGE.
- 2.) ENTER RANDOM PRIZE MESSAGE.
- 3.) ENABLE/DISABLE COUPON AWARDS.
- 4.) SET LEVEL PRIZE AMOUNT.
- 5.) SET RANDOM WINNING %.

**ERROR CONDITIONS:**

There are no error conditions directly associated with this function.

Compliments of: [www.atndepot.com](http://www.atndepot.com)

## SECTION 5 - MANAGEMENT FUNCTIONS

### FUNCTION: ENTER LEVEL PRIZE MSG.

**FACTORY DEFAULT: NONE**

#### ACCESS INSTRUCTIONS:

- 1.) Select TERMINAL CONFIGURATION from the MANAGEMENT FUNCTIONS menu.
- 2.) Select RANDOM/LEVEL PRIZE COUPONS from the TERMINAL CONFIGURATION menu.
- 3.) Select ENTER LEVEL PRIZE MSG.

F1 CENTER LINE LEFT F6  
F2 CLEAR ALL CENTER F7  
F3 CLEAR LINE RIGHT F8  
F4 CASE UPPER

#### DESCRIPTION:

The LEVEL PRIZE MESSAGE consists of four lines of text that are printed on the Level Prize receipt and report. The text can be full alphanumeric text. Enter letters, numbers and punctuation as follows:

The keys along either side of the display are used with the numeric keys on the main keypad to permit entry of alphanumeric characters. The keys on the left side of the display are designated <F1> through <F4>. The keys on the right side of the display are <F6> through <F8>. The <F1> key centers the text on the line where the cursor appears. The <F2> key erases all text in the current message. <F3> clears the text on the line the cursor is currently appearing.

KEY	1	2	3	4	5	6	7	8	9	0
F4 UPPER	.	.	.	.	.	.	.	.	.	.
No Shift	1	2	3	4	5	6	7	8	9	0
F6 Left	Q	A	D	G	J	M	P	T	W	,
F7 Center	Z	B	E	H	K	N	R	U	X	.
F8 Right	Sp	C	F	I	L	O	S	V	Y	-
F4 LOWER										
No Shift	!	@	#	\$	%	^	&	*	( )	
F6 Left	q	a	d	g	j	m	p	t	w	'
F7 Center	z	b	c	h	k	n	r	u	x	+
F8 Right	&	c	f	i	l	o	s	v	y	=

The <F4> Key is used similarly to a CAPS LOCK key on a computer keyboard. Pressing the <F4> key toggles between uppercase and lowercase. To enter an alphabetic or punctuation character, one of the <F6> through <F8> keys must be pressed, followed by one of the numeric keys. The resultant character will be as indicated in the table. Press the <OK> key to save the changes made. If you make a mistake and want to start over, press the CANCEL key to discard any changes made to that point.

#### ERROR CONDITIONS:

There are no error conditions directly associated with this function.

## SECTION 5 - MANAGEMENT FUNCTIONS

**FUNCTION: ENTER RANDOM PRIZE MSG.**

**FACTORY DEFAULT: NONE**

**ACCESS INSTRUCTIONS:**

- 1.) Select TERMINAL CONFIGURATION from the MANAGEMENT FUNCTIONS menu.
- 2.) Select RANDOM/LEVEL PRIZE COUPONS from the TERMINAL CONFIGURATION menu.
- 3.) Select ENTER RANDOM PRIZE MSG.

F1 CENTER LINE	LEFT F6
F2 CLEAR ALL	CENTER F7
F3 CLEAR LINE	RIGHT F8
F4 CASE UPPER	

**DESCRIPTION:**

The RANDOM PRIZE MESSAGE consists of four lines of text that are printed on the Random Coupon receipt and report. The text can be full alphanumeric text. Enter desired letters, numbers and punctuation as follows:

The keys along either side of the display are used with the numeric keys on the main keypad to permit entry of alphanumeric characters. The keys on the left side of the display are designated <F1> through <F4>. The keys on the right side of the display are <F6> through <F8>. The <F1> key centers the text on the line where the cursor appears. The <F2> key erases all text in the current message. <F3> clears the text on the line the cursor is currently appearing.

KEY	1	2	3	4	5	6	7	8	9	0
F4 UPPER	.	.	.	.	.	.	.	.	.	.
No Shift	1	2	3	4	5	6	7	8	9	0
F6 Left	Q	A	D	G	J	M	P	T	W	,
F7 Center	Z	B	E	H	K	N	R	U	X	.
F8 Right	Sp	C	F	I	L	O	S	V	Y	-
F4 LOWER										
No Shift	!	@	#	\$	%	^	&	*	(	)
F6 Left	q	a	d	g	j	m	p	t	w	'
F7 Center	z	b	c	h	k	n	r	u	x	+
F8 Right	&	c	f	i	l	o	s	v	y	=

The <F4> Key is used similarly to a CAPS LOCK key on a computer keyboard. Pressing the <F4> key toggles between uppercase and lowercase. To enter an alphabetic or punctuation character, one of the <F6> through <F8> keys must be pressed, followed by one of the numeric keys. The resultant character will be as indicated in the table. Press the <OK> key to save the changes made. If you make a mistake and want to start over, press the CANCEL key to discard any changes made to that point.

**ERROR CONDITIONS:**

There are no error conditions directly associated with this function.

Compliments of: [www.atmdepot.com](http://www.atmdepot.com)

## SECTION 5 - MANAGEMENT FUNCTIONS

### FUNCTION: ENABLE/DISABLE COUPON AWARDS

**FACTORY DEFAULT: DISABLED**

#### ACCESS INSTRUCTIONS:

- 1.) Select **TERMINAL CONFIGURATION** from the **MANAGEMENT FUNCTIONS** menu.
- 2.) Select **RANDOM/LEVEL PRIZE COUPONS** from the **TERMINAL CONFIGURATION** menu.
- 3.) Select the **ENABLE/DISABLE COUPON AWARDS** option.
- 4.) Select **ENABLE** OR **DISABLE** from the menu displayed.



#### DESCRIPTION:

This function provides access to a menu that allows the operator to **ENABLE** or **DISABLE** all printed coupon awards. If **ENABLED**, eligible transactions will be checked for award. If **DISABLED**, no coupons will be issued.

#### ERROR CONDITIONS:

There are no error conditions directly associated with this function.

## SECTION 5 - MANAGEMENT FUNCTIONS

**FUNCTION: SET LEVEL PRIZE AMOUNT**

**FACTORY DEFAULT: '\$0.00'**

**ACCESS INSTRUCTIONS:**

- 1.) Select **TERMINAL CONFIGURATION** from the **MANAGEMENT FUNCTIONS** menu.
- 2.) Select **RANDOM/LEVEL PRIZE COUPONS** from the **TERMINAL CONFIGURATION** menu.
- 3.) Select the **SET LEVEL PRIZE AMOUNT** option.
- 4.) Enter the amount in dollars and press "<OK>".

**DESCRIPTION:**

This function sets the threshold level at which the level prize coupon will be printed. Withdrawing an amount equal to or greater than the value set here will print the level prize coupon.

**NOTE:** If the level coupon is awarded, the random coupon parameter will not be tested for award.

**ERROR CONDITIONS:**

There are no error conditions directly associated with this function.

LEVEL PRIZE COUPON THRESHOLD

\$     . 00

ENTER NEW LEVEL, THEN PRESS OK

CHANGE

EXIT

Compliments of: [www.atndepot.com](http://www.atndepot.com)

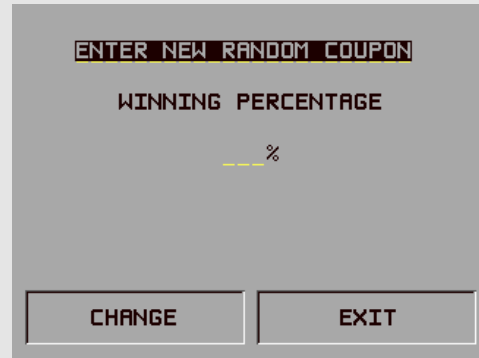
## SECTION 5 - MANAGEMENT FUNCTIONS

### FUNCTION: SET RANDOM WINNING %

**FACTORY DEFAULT: '0%'**

#### ACCESS INSTRUCTIONS:

- 1.) Select **TERMINAL CONFIGURATION** from the **MANAGEMENT FUNCTIONS** menu.
- 2.) Select **RANDOM/LEVEL PRIZE COUPONS** from the **TERMINAL CONFIGURATION** menu.
- 3.) Select the **SET RANDOM WINNING %** option.
- 4.) Select the **CHANGE** option.
- 5.) Enter the new random percentage and press **<OK>**.



#### DESCRIPTION:

This function sets the frequency at which the random prize coupons will be printed. The random coupon is won by a random number of transactions of any type. The winning percentage can be set from 0 to 100%. For example, if the winning percentage is set to 10%, then 1 out of every 10 transactions will be awarded a prize.

#### ERROR CONDITIONS:

There are no error conditions directly associated with this function.

Compliments of: [www.atmdepot.com](http://www.atmdepot.com)



## SECTION 5 - MANAGEMENT FUNCTIONS

**FUNCTION: CHANGE MESSAGES**

**FACTORY DEFAULT: N/A**

**ACCESS INSTRUCTIONS:**

- 1.) Select **TERMINAL CONFIGURATION** from the **MANAGEMENT FUNCTIONS** menu.
- 2.) Select **CHANGE MESSAGES**.

SELECT MESSAGE TYPE  
TO BE CHANGED

MARKETING MESSAGE	EXIT MESSAGE
SURCHARGE MESSAGES	STORE MESSAGE
WELCOME MESSAGE	TERMINAL OWNER
SURCHARGE OWNER	EXIT

**DESCRIPTION:**

The **CHANGE MESSAGES** option of the **TERMINAL CONFIGURATION** menu allows information for the following screens to be changed by the terminal operator or a service technician:

- 1.) **MARKETING MESSAGE**
- 2.) **SURCHARGE MESSAGES**
- 3.) **WELCOME MESSAGE**
- 4.) **SURCHARGE OWNER**
- 5.) **EXIT MESSAGE**
- 6.) **STORE MESSAGE**
- 7.) **TERMINAL OWNER**

**ERROR CONDITIONS:**

There are no error conditions directly associated with this function

Compliments of: [www.atndepot.com](http://www.atndepot.com)

# SECTION 5 - MANAGEMENT FUNCTIONS

## FUNCTION: MARKETING MESSAGE

**FACTORY DEFAULT: NONE**

**ACCESS INSTRUCTIONS:**

- 1.) Select **TERMINAL CONFIGURATION** from the **MANAGEMENT FUNCTIONS** menu.
- 2.) Select **CHANGE MESSAGES**.
- 3.) Select **MARKETING MESSAGE**.

F1 CENTER LINE LEFT F6  
 F2 CLEAR ALL CENTER F7  
 F3 CLEAR LINE RIGHT F8  
 F4 CASE UPPER

**DESCRIPTION:**

The **MARKETING MESSAGE** function allows you to compose a message that will appear on any printed products that include the store message (e.g. customer receipts, day closes, coupons, etc.). The message can be up to four lines long. Enter letters, numbers and punctuation as follows:

KEY	1	2	3	4	5	6	7	8	9	0
<b>F4 UPPER</b>										
No Shift	1	2	3	4	5	6	7	8	9	0
<b>F6 Left</b>	Q	A	D	G	J	M	P	T	W	,
<b>F7 Center</b>	Z	B	E	H	K	N	R	U	X	.
<b>F8 Right</b>	Sp	C	F	I	L	O	S	V	Y	-
<b>F4 LOWER</b>										
No Shift	!	@	#	\$	%	^	&	*	(	)
<b>F6 Left</b>	q	a	d	g	j	m	p	t	w	'
<b>F7 Center</b>	z	b	c	h	k	n	r	u	x	+
<b>F8 Right</b>	&	c	f	i	l	o	s	v	y	=

The keys along either side of the display are used with the numeric keys on the main keypad to permit entry of alphanumeric characters. The keys on the left side of the display are designated <F1> through <F4>. The keys on the right side of the display are <F6> through <F8>. The <F1> key centers the text on the line where the cursor appears. The <F2> key erases all text in the current message. <F3> clears the text on the line the cursor is currently appearing.

The <F4> Key is used similarly to a CAPS LOCK key on a computer keyboard. Pressing the <F4> key toggles between uppercase and lowercase. To enter an alphabetic or punctuation character, one of the <F6> through <F8> keys must be pressed, followed by one of the numeric keys. The resultant character will be as indicated in the table. Press the <OK> key to save the changes made. If you make a mistake and want to start over, press the CANCEL key to discard any changes made to that point.

**ERROR CONDITIONS:**

There are no error conditions directly associated with this function.

Compliments of: [www.atndepot.com](http://www.atndepot.com)

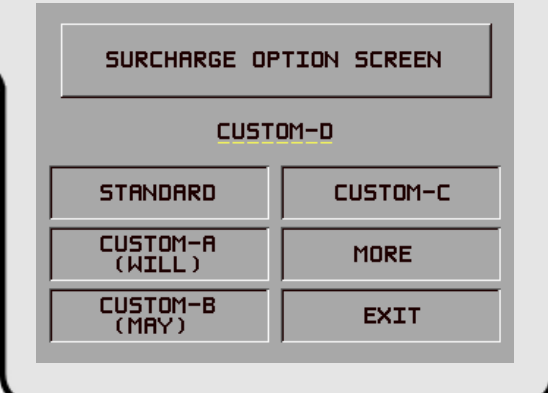
# SECTION 5 - MANAGEMENT FUNCTIONS

**FUNCTION: SURCHARGE MESSAGES**

**FACTORY DEFAULT: 'STANDARD'**

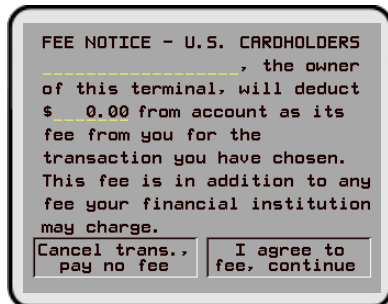
**ACCESS INSTRUCTIONS:**

- 1.) Select TERMINAL CONFIGURATION from the MANAGEMENT FUNCTIONS menu.
- 2.) Select CHANGE MESSAGES.
- 3.) Select SURCHARGE MESSAGES

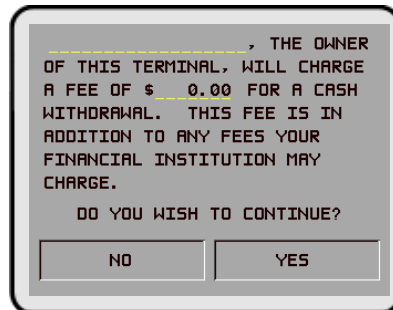


**DESCRIPTION:**

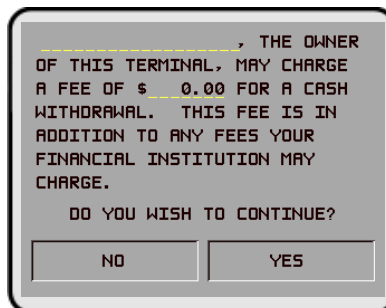
This function is used to select the surcharge message that will be displayed to the customer. Press the button next to the desired message to select it. Message options STANDARD, A, B and C are accessed from the first SURCHARGE OPTION SCREEN. The MORE option leads to a second screen containing message options D, E, F, G, and H.



STANDARD



CUSTOM-A



CUSTOM-B

Compliments of: [www.atmdepot.com](http://www.atmdepot.com)

## SECTION 5 - MANAGEMENT FUNCTIONS

\_\_\_\_\_, THE OWNER OF THIS TERMINAL, WILL DEDUCT \$ \_\_\_\_ 0.00 FROM YOUR ACCOUNT AS ITS FEE FROM YOU FOR THE TRANSACTION YOU HAVE CHOSEN. THIS FEE IS IN ADDITION TO ANY FEE YOUR FINANCIAL INSTITUTION MAY CHARGE.

DO YOU WISH TO CONTINUE?

NO, CANCEL PAY NO FEE	YES, I AGREE CONTINUE
--------------------------	--------------------------

CUSTOM-C

FEE NOTICE

In addition to any institutional fees you may be charged by your bank, the owner of this terminal \_\_\_\_\_ has assessed a \$ \_\_\_\_ 0.00 fee to all US cardholders per cash withdrawal.

NO	YES
----	-----

CUSTOM-D

\_\_\_\_\_, THE OPERATOR OF THIS TERMINAL, WILL CHARGE A FEE OF \$ \_\_\_\_\_ FOR A WITHDRAWAL

THIS FEE IS IN ADDITION TO ANY FEES YOUR INSTITUTION MAY CHARGE.

CANCEL WITH NO FEE	CONTINUE WITH FEE
-----------------------	----------------------

CUSTOM-E

\_\_\_\_\_, THE OPERATOR OF THIS TERMINAL, WILL CHARGE A FEE OF \$ \_\_\_\_\_ FOR A WITHDRAWAL PERFORMED BY A US CARD HOLDER

THIS FEE IS IN ADDITION TO ANY FEES YOUR INSTITUTION MAY CHARGE.

CANCEL WITH NO FEE	CONTINUE WITH FEE
-----------------------	----------------------

CUSTOM-F

\_\_\_\_\_, THE OPERATOR OF THIS TERMINAL, WILL CHARGE A FEE OF \$ \_\_\_\_\_ OR % \_\_\_\_\_ OF THE TRANSACTION AMOUNT WHICHEVER IS LESSER FOR A WITHDRAWAL

THIS FEE IS IN ADDITION TO ANY FEES YOUR INSTITUTION MAY CHARGE

CANCEL WITH NO FEE	CONTINUE WITH FEE
-----------------------	----------------------

CUSTOM-G

\_\_\_\_\_, THE OPERATOR OF THIS TERMINAL, WILL CHARGE A FEE OF \$ \_\_\_\_\_ OR % \_\_\_\_\_ OF THE TRANSACTION AMOUNT WHICHEVER IS LESSER FOR A WITHDRAWAL PERFORMED BY A US CARD HOLDER

THIS FEE IS IN ADDITION TO ANY FEES YOUR INSTITUTION MAY CHARGE

CANCEL WITH NO FEE	CONTINUE WITH FEE
-----------------------	----------------------

CUSTOM-H

### ERROR CONDITIONS:

There are no error conditions directly associated with this function.

# SECTION 5 - MANAGEMENT FUNCTIONS

## FUNCTION: WELCOME MESSAGE

FACTORY DEFAULT: 'WELCOME TO miniATM'

### ACCESS INSTRUCTIONS:

- 1.) Select TERMINAL CONFIGURATION from the MANAGEMENT FUNCTIONS menu.
- 2.) Select CHANGE MESSAGES.
- 3.) Select Welcome Message.

F1 CENTER LINE	LEFT F6
F2 CLEAR ALL	CENTER F7
F3 CLEAR LINE	RIGHT F8
F4 CASE UPPER	

### DESCRIPTION:

The Welcome Message consists of three lines of text that are printed at the top of the customer welcome screen. The text can be full alphanumeric text. Enter letters, numbers and punctuation as follows:

The keys along either side of the display are used with the numeric keys on the main keypad to permit entry of alphanumeric characters. The keys on the left side of the display are designated <F1> through <F4>. The keys on the right side of the display are <F6> through <F8>. The <F1> key centers the text on the line where the cursor appears. The <F2> key erases all text in the current message. <F3> clears the text on the line the cursor is currently appearing.

The <F4> Key is used similarly to a CAPS LOCK key on a computer keyboard. Pressing the <F4> key toggles between uppercase and lowercase. To enter an alphabetic or punctuation character, one of the <F6> through <F8> keys must be pressed, followed by one of the numeric keys. The resultant character will be as indicated in the table. Press the <OK> key to save the changes made. If you make a mistake and want to start over, press the CANCEL key to discard any changes made to that point.

KEY	1	2	3	4	5	6	7	8	9	0
F4 UPPER	.	.	.	.	.	.	.	.	.	.
No Shift	1	2	3	4	5	6	7	8	9	0
F6 Left	Q	A	D	G	J	M	P	T	W	,
F7 Center	Z	B	E	H	K	N	R	U	X	.
F8 Right	Sp	C	F	I	L	O	S	V	Y	-
F4 LOWER										
No Shift	!	@	#	\$	%	^	&	*	(	)
F6 Left	q	a	d	g	j	m	p	t	w	'
F7 Center	z	b	c	h	k	n	r	u	x	+
F8 Right	&	c	f	i	l	o	s	v	y	=

### ERROR CONDITIONS:

There are no error conditions directly associated with this function.

Compliments of: [www.atndepot.com](http://www.atndepot.com)

## SECTION 5 - MANAGEMENT FUNCTIONS

### FUNCTION: SURCHARGE OWNER

**FACTORY DEFAULT: NONE**

#### ACCESS INSTRUCTIONS:

- 1.) Select TERMINAL CONFIGURATION from the MANAGEMENT FUNCTIONS menu.
- 2.) Select CHANGE MESSAGES.
- 3.) Select SURCHARGE OWNER.



#### DESCRIPTION:

The name of the SURCHARGE OWNER is stored in the terminal and printed on the Receipt Printer Test Report. The name of the SURCHARGE OWNER is entered directly into the terminal.

To enter a digit 0-9, simply press the key that has that digit. To enter a letter, first press the <BLUE> key, then press the key that has the letter you want on it. The first press of the key will display the first character above the number. Subsequent presses will display the characters in sequence. When the character you want is displayed, press the <RIGHT ARROW> key to 'lock in' the letter. If your next character is a letter, you must press the <BLUE> key again.

The name can be up to 18 characters long.

#### ERROR CONDITIONS:

There are no error conditions directly associated with this function

# SECTION 5 - MANAGEMENT FUNCTIONS

**FUNCTION: EXIT MESSAGE**

**FACTORY DEFAULT:** 'Thank's for Using miniATM'

**ACCESS INSTRUCTIONS:**

- 1.) Select TERMINAL CONFIGURATION from the MANAGEMENT FUNCTIONS menu.
- 2.) Select CHANGE MESSAGES.
- 3.) Select EXIT MESSAGE.

F1 CENTER LINE	LEFT F6
F2 CLEAR ALL	CENTER F7
F3 CLEAR LINE	RIGHT F8
F4 CASE UPPER	

**DESCRIPTION:**

The Exit Message consists of three lines of text that are printed on the terminal display at the conclusion of a transaction. The text can be full alphanumeric text. Enter letters, numbers and punctuation as follows:

The keys along either side of the display are used with the numeric keys on the main keypad to permit entry of alphanumeric characters. The keys on the left side of the display are designated <F1> through <F4>. The keys on the right side of the display are <F6> through <F8>. The <F1> key centers the text on the line where the cursor appears. The <F2> key erases all text in the current message. <F3> clears the text on the line the cursor is currently appearing.

KEY	1	2	3	4	5	6	7	8	9	0
F4 UPPER	.	.	.	.	.	.	.	.	.	.
No Shift	1	2	3	4	5	6	7	8	9	0
F6 Left	Q	A	D	G	J	M	P	T	W	,
F7 Center	Z	B	E	H	K	N	R	U	X	.
F8 Right	Sp	C	F	I	L	O	S	V	Y	-
F4 LOWER										
No Shift	!	@	#	\$	%	^	&	*	(	)
F6 Left	q	a	d	g	j	m	p	t	w	'
F7 Center	z	b	c	h	k	n	r	u	x	+
F8 Right	&	c	f	i	l	o	s	v	y	=

The <F4> Key is used similarly to a CAPS LOCK key on a computer keyboard. Pressing the <F4> key toggles between uppercase and lowercase. To enter an alphabetic or punctuation character, one of the <F6> through <F8> keys must be pressed, followed by one of the numeric keys. The resultant character will be as indicated in the table. Press the <OK> key to save the changes made. If you make a mistake and want to start over, press the CANCEL key to discard any changes made to that point.

**ERROR CONDITIONS:**

There are no error conditions directly associated with this function.

Compliments of: [www.atndepot.com](http://www.atndepot.com)

## SECTION 5 - MANAGEMENT FUNCTIONS

### FUNCTION: STORE MESSAGE

**FACTORY DEFAULT: SEE NOTE**

**ACCESS INSTRUCTIONS:**

- 1.) Select **TERMINAL CONFIGURATION** from the **MANAGEMENT FUNCTIONS** menu.
- 2.) Select **CHANGE MESSAGES**.
- 3.) Select **STORE MESSAGE**.

F1 CENTER LINE	LEFT F6
F2 CLEAR ALL	CENTER F7
F3 CLEAR LINE	RIGHT F8
F4 CASE UPPER	

**DESCRIPTION:**

The **STORE MESSAGE** consists of four lines of text that are printed on the customer receipt. The text can be full alphanumeric text. Enter letters, numbers and punctuation as follows:

The keys along either side of the display are used with the numeric keys on the main keypad to permit entry of alphanumeric characters. The keys on the left side of the display are designated <F1> through <F4>. The keys on the right side of the display are <F6> through <F8>. The <F1> key centers the text on the line where the cursor appears. The <F2> key erases all text in the current message. <F3> clears the text on the line the cursor is currently appearing.

KEY	1	2	3	4	5	6	7	8	9	0
<b>F4 UPPER</b>	.	.	.	.	.	.	.	.	.	.
No Shift	1	2	3	4	5	6	7	8	9	0
F6 Left	Q	A	D	G	J	M	P	T	W	,
F7 Center	Z	B	E	H	K	N	R	U	X	.
F8 Right	Sp	C	F	I	L	O	S	V	Y	-
<b>F4 LOWER</b>	.	.	.	.	.	.	.	.	.	.
No Shift	!	@	#	\$	%	^	&	*	( )	
F6 Left	q	a	d	g	j	m	p	t	w	'
F7 Center	z	b	c	h	k	n	r	u	x	+
F8 Right	&	c	f	i	l	o	s	v	y	=

The <F4> Key is used similarly to a **CAPS LOCK** key on a computer keyboard. Pressing the <F4> key toggles between uppercase and lowercase. To enter an alphabetic or punctuation character, one of the <F6> through <F8> keys must be pressed, followed by one of the numeric keys. The resultant character will be as indicated in the table. Press the <OK> key to save the changes made. If you make a mistake and want to start over, press the **CANCEL** key to discard any changes made to that point.

**NOTE: ‘\*THIS IS LINE (1-4) OF THE STORE MESSAGE\*’**

**ERROR CONDITIONS:**

There are no errors directly associated with this function.



## SECTION 5 - MANAGEMENT FUNCTIONS

**FUNCTION: TERMINAL OWNER**

**FACTORY DEFAULT: NONE**

**ACCESS INSTRUCTIONS:**

- 1.) Select TERMINAL CONFIGURATION from the MANAGEMENT FUNCTIONS menu.
- 2.) Select CHANGE MESSAGES.
- 3.) Select TERMINAL OWNER.

ENTER OWNER'S NAME

THEN PRESS OK

-----

-----

**DESCRIPTION:**

The name of the TERMINAL OWNER is stored in the terminal and displayed to the customer in the surcharge warning message. The name is entered directly into the terminal.

To enter a digit 0-9, simply press the key that has that digit. To enter a letter, first press the <BLUE> key, then press the key that has the letter you want on it. The first press of the key will display the first character above the number. Subsequent presses will display the characters in sequence. When the character you want is displayed, press the <RIGHT ARROW> key to 'lock in' the letter. If your next character is a letter, you must press the <BLUE> key again.

The name can be up to 18 characters long.

**ERROR CONDITIONS:**

There are no error conditions directly associated with this function.

Compliments of: [www.atndepot.com](http://www.atndepot.com)

## SECTION 5 - MANAGEMENT FUNCTIONS

### FUNCTION: TERMINAL PARAMETERS

**FACTORY DEFAULT: N/A**

#### ACCESS INSTRUCTIONS:

- 1.) Select **TERMINAL CONFIGURATION** from the **MANAGEMENT FUNCTIONS** menu.
- 2.) Select **SET TERMINAL PARAMETERS**.



#### DESCRIPTION:

Selecting **SET TERMINAL PARAMETERS** from the **TERMINAL CONFIGURATION** menu allows the following Cash Dispenser operating parameters to be viewed or changed:

- 1.) SET TERMINAL #
- 2.) RESET SEQ #
- 3.) SURCHARGE MODE
- 4.) CASSETTE SETUP
- 5.) KEY MANAGEMENT
- 6.) TELEPHONE
- 7.) MORE

#### ERROR CONDITIONS:

There are no error conditions directly associated with this function.

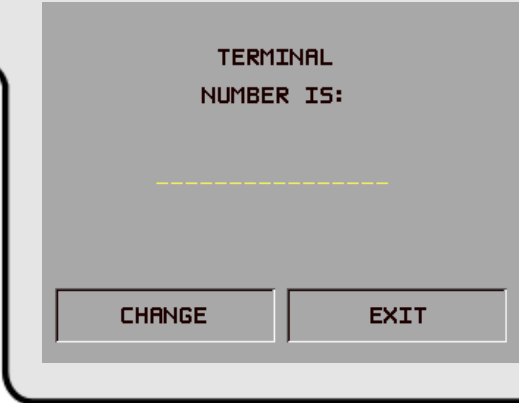
## SECTION 5 - MANAGEMENT FUNCTIONS

**FUNCTION: SET TERMINAL #**

**FACTORY DEFAULT: NONE**

**ACCESS INSTRUCTIONS:**

- 1.) Select TERMINAL CONFIGURATION from the MANAGEMENT FUNCTIONS menu.
- 2.) Select SET TERMINAL PARAMETERS.
- 3.) Choose the SET TERMINAL # option.



**DESCRIPTION:**

The TERMINAL # is a unique string of characters provided by your processor to identify the Cash Dispenser when a transaction is taking place. It can contain numbers and letters. The minimum number of characters is 6 and the maximum is 16.

This parameter **MUST** be set before the Cash Dispenser can go on-line AND before the communications key can be downloaded.

When this function is selected, the current TERMINAL # is displayed. If it is to be changed, select CHANGE.

To enter a digit 0-9, press the key that has that digit. To enter a letter, first press the <BLUE> key, then press the key that has the letter you want on it. The first press of the key will display the first character above the number. Subsequent presses will display the characters in sequence. When the character you want is displayed, press the <RIGHT ARROW> key to ‘lock in’ the letter. If your next character is a letter, you must press the <BLUE> key again.

When you have entered all of the characters, press the <OK> key.

**ERROR CONDITIONS:**

The Cash Dispenser will not function on-line without a valid TERMINAL #.

Compliments of: [www.atndepot.com](http://www.atndepot.com)

## SECTION 5 - MANAGEMENT FUNCTIONS

**FUNCTION: RESET SEQ #**

**FACTORY DEFAULT: N/A**

**ACCESS INSTRUCTIONS:**

- 1.) Select **TERMINAL CONFIGURATION** from the **MANAGEMENT FUNCTIONS** menu.
- 2.) Select **SET TERMINAL PARAMETERS**.
- 3.) Choose the **RESET SEQ #** option.

<b>TERMINAL PARAMETERS</b>	
<b>SET TERMINAL #</b>	<b>KEY MANAGEMENT</b>
<b>RESET SEQ. #</b>	<b>TELEPHONE</b>
<b>SURCHARGE MODE</b>	<b>MORE</b>
<b>CASSETTE SETUP</b>	<b>EXIT</b>

**DESCRIPTION:**

**NOTE:** This feature is not supported by all processors.

Select the **RESET SEQ. #** option from the **TERMINAL PARAMETER** menu to reset the sequence number that is printed on the journal printout and receipt to **'00000000'**.

Resetting the **SEQUENCE #** is an operation that should usually be performed at the request of your processor. Use of this function is not required during normal operation.

**ERROR CONDITIONS:**

There are no error conditions directly associated with this function.

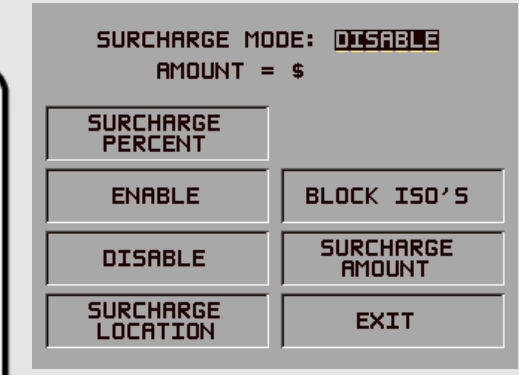
## SECTION 5 - MANAGEMENT FUNCTIONS

**FUNCTION: SURCHARGE MODE**

**FACTORY DEFAULT: N/A**

**ACCESS INSTRUCTIONS:**

- 1.) Select **TERMINAL CONFIGURATION** from the **MANAGEMENT FUNCTIONS** menu.
- 2.) Select **SET TERMINAL PARAMETERS**.
- 3.) Choose the **SURCHARGE MODE** option.



The screenshot shows a terminal screen with the following text and buttons:

```

SURCHARGE MODE: DISABLE
AMOUNT = $

[ SURCHARGE PERCENT ]
[ ENABLE ] [ BLOCK ISO'S ]
[ DISABLE ] [ SURCHARGE AMOUNT ]
[ SURCHARGE LOCATION ] [ EXIT ]
    
```

**DESCRIPTION:**

Selecting the **SURCHARGE MODE** option from the **SET TERMINAL PARAMETERS** menu allows the terminal operator or service technician to change the following surcharge options:

- 1.) **SURCHARGE PERCENT**
- 2.) **ENABLE/DISABLE SURCHARGE MODE**
- 3.) **SURCHARGE LOCATION**
- 4.) **BLOCK ISO'S**
- 5.) **SURCHARGE AMOUNT**

**ERROR CONDITIONS:**

There are no error conditions directly associated with this function.

Compliments of: [www.atndepot.com](http://www.atndepot.com)

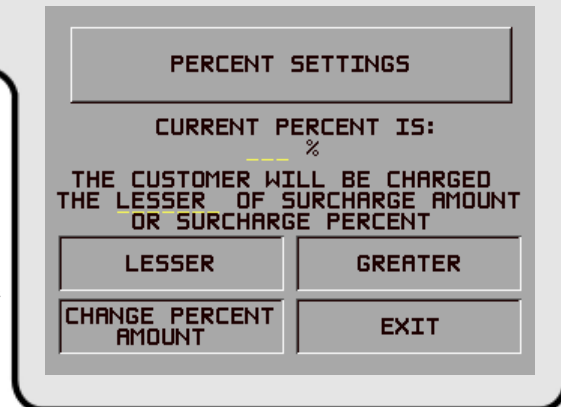
## SECTION 5 - MANAGEMENT FUNCTIONS

### FUNCTION: SURCHARGE PERCENT

**FACTORY DEFAULT: N/A**

#### ACCESS INSTRUCTIONS:

- 1.) Select TERMINAL CONFIGURATION from the MANAGEMENT FUNCTIONS menu.
- 2.) Select SET TERMINAL PARAMETERS.
- 3.) Choose the SURCHARGE MODE option.
- 4.) Select SURCHARGE PERCENT.



#### DESCRIPTION:

The SURCHARGE PERCENT option on the SURCHARGE MODE screen brings up the PERCENT SETTINGS screen, which enables you to enter a surcharge percentage amount, as well as choose the LESSER or GREATER option that is applicable to the surcharge. *Remember that these options must conform to the processor's requirements or other applicable commerce regulations.*

To enter a surcharge percent value press the CHANGE PERCENT AMOUNT key. the ENTER NEW AMOUNT AND PRESS OK prompt replaces the CURRENT PERCENT IS: field. Enter the applicable percentage value (from 1 and 99 percent) and press "OK".

If the processor or other authority requires that the surcharge be the *lesser* of either the surcharge amount or surcharge percentage, select the LESSER option. If the surcharge must be the *greater* of either the surcharge amount or surcharge percentage, select the GREATER option.

This value is stored in the terminal and will be displayed to the customer on the applicable surcharge message screen. The percent settings must be correct to ensure surcharge messages CUSTOM-G and CUSTOM-H are accurate!

#### ERROR CONDITIONS:

If a fixed surcharge amount is to be used (surcharge percent not used) you must ensure the surcharge comparison option is set to GREATER and the surcharge percent is set to zero (0). This will ensure that only the fixed surcharge amount value will be displayed to the customer. *Failure to do so can cause an incorrect surcharge value to be reported to the customer.*

## SECTION 5 - MANAGEMENT FUNCTIONS

**FUNCTION: ENABLE/DISABLE SURCHARGE**

**FACTORY DEFAULT: DISABLED**

**ACCESS INSTRUCTIONS:**

- 1.) Select **TERMINAL CONFIGURATION** from the **MANAGEMENT FUNCTIONS** menu.
- 2.) Select **SET TERMINAL PARAMETERS**.
- 3.) Choose the **SURCHARGE MODE** option.
- 4.) Select **ENABLE** or **DISABLE**, as appropriate.

SURCHARGE MODE: **DISABLE**  
AMOUNT = \$

SURCHARGE PERCENT	BLOCK ISO'S
ENABLE	SURCHARGE AMOUNT
DISABLE	EXIT
SURCHARGE LOCATION	

**DESCRIPTION:**

Some networks allow a surcharge, or terminal fee, to be imposed on withdrawal transactions. If surcharges are in use on your network, you are required to notify the customer of an additional fee before the transaction is processed. He or she must be given a chance to cancel the transaction. Setting the **SURCHARGE MODE** to **ENABLED** will cause a surcharge notification screen to be displayed at some point prior to final processing of the transaction. The customer is given the choice of canceling the transaction at no charge or of continuing.

If your network does not allow surcharges, select the **DISABLE** option to turn off presentation of the surcharge notification message.

**ERROR CONDITIONS:**

Be sure to **ENABLE** this mode if your network allows surcharges.

Compliments of: [www.atndepot.com](http://www.atndepot.com)


## SECTION 5 - MANAGEMENT FUNCTIONS

**FUNCTION: SURCHARGE LOCATION**

**FACTORY DEFAULT: BEGINNING**

**ACCESS INSTRUCTIONS:**

- 1.) Select **TERMINAL CONFIGURATION** from the **MANAGEMENT FUNCTIONS** menu.
- 2.) Select **SET TERMINAL PARAMETERS**.
- 3.) Choose the **SURCHARGE MODE** option.
- 4.) Choose the **SURCHARGE LOCATION** option.



The screenshot shows a terminal screen with a grey background. At the top, it says "SURCHARGE MESSAGE LOCATION". Below that, the word "BEGINNING" is displayed in a larger font and underlined. At the bottom, there are three rectangular buttons: "BEGINNING" on the left, "ENDING" on the right, and "EXIT" centered below them.

### DESCRIPTION:

The **SURCHARGE LOCATION** function determines where the terminal user is presented with the surcharge notification message. The surcharge notification message informs the customer about any surcharge that is applicable to the transaction they are completing. When the message appears the terminal user is given the option of accepting the surcharge and continuing the transaction, or canceling the transaction without incurring any charges. The surcharge amount identified in the notification message does not include any additional charges that the bank sponsoring the card may add to the cost of processing a transaction.

Selecting the **BEGINNING** option displays the applicable surcharge notification message immediately after the terminal user removes the card from the card reader and before their PIN is entered into the terminal.

Selecting the **ENDING** option displays the surcharge notification message after the terminal user has selected an amount from the **FAST CASH** menu or entered the amount of the withdrawal and pressed the "<OK>" key to complete the transaction.

### ERROR CONDITIONS:

There are no error conditions directly associated with this function.



## SECTION 5 - MANAGEMENT FUNCTIONS

**FUNCTION: BLOCK ISO'S**

**FACTORY DEFAULT: NONE**

**ACCESS INSTRUCTIONS:**

- 1.) Select **TERMINAL CONFIGURATION** from the **MANAGEMENT FUNCTIONS** menu.
- 2.) Select **SET TERMINAL PARAMETERS**.
- 3.) Choose the **SURCHARGE MODE** option.
- 4.) Choose the **BLOCK ISO'S** option.

**DESCRIPTION:**

This function is used to block surcharging and to disable the display of surcharge messages for transactions that use a particular financial institution's ATM or Credit Card. Entering the financial institution's unique ISO (International Standards Organization) Number on this screen enables the function.

The terminal can store up to 100 ISO numbers to block at one time; however, only 5 numbers can be entered using the **BLOCK ISO'S** screen. Additional ISO numbers (up to the 100-number limit) must be downloaded to the terminal using Triton Connect management software.

From 1 to 9 digits may be used. The terminal will compare the card number to all current ISO numbers to the length of each number. For example, three ISO numbers are entered , including '581234', '46', and '3785'. Any card beginning with '46' would match and cause the surcharge notification message to be suppressed (if surcharging were enabled). A card with the starting number '581235' would not match and therefore a surcharge message would appear. With this technique cards from many issuers can be supported. The more digits entered the fewer the number of different cards that will match.

If a card number matches an ISO number to be blocked, the customer will not see the surcharge notification screen. The processor will also be notified of this in the transaction. Most processors support this function. Before enabling this feature, check to make sure your particular processor supports it. Otherwise, your terminal could be in violation of network rules and be sanctioned.

SELECT ISO TO CHANGE  
ENTER NEW ISO THEN PRESS 'OK'

---

-----	-----
-----	-----
-----	<b>EXIT</b>

Compliments of: [www.atmdepot.com](http://www.atmdepot.com)

## SECTION 5 - MANAGEMENT FUNCTIONS

---

To enter or change an ISO go to the SELECT ISO TO CHANGE screen and perform the following:

- 1.) Press the Screen Key next to the block where the new ISO will be entered or an ISO changed.
- 2.) Enter the ISO number (up to six digits in length).
- 3.) Press the “<OK>” key.

If more than one ISO must be entered repeat steps 1 through 3 until all ISO are entered (up to five ISO numbers may be entered). As noted previously, additional ISO numbers can be entered via Triton Connect, up to the 100-number limit.

### **ERROR CONDITIONS:**

There are no error conditions directly associated with this function.

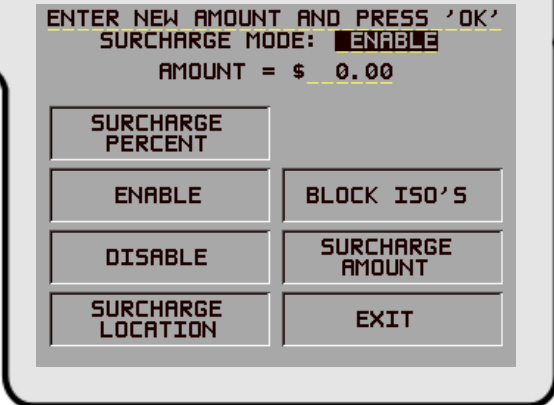
## SECTION 5 - MANAGEMENT FUNCTIONS

**FUNCTION: SURCHARGE AMOUNT**

**FACTORY DEFAULT: '\$0.00'**

**ACCESS INSTRUCTIONS:**

- 1.) Select **TERMINAL CONFIGURATION** from the **MANAGEMENT FUNCTIONS** menu.
- 2.) Select **SET TERMINAL PARAMETERS**.
- 3.) Choose the **SURCHARGE MODE** option.
- 4.) Choose the **SURCHARGE AMOUNT** option.



**DESCRIPTION:**

The surcharge amount will be entered directly on the SURCHARGE MODE screen. The value you enter here will be displayed to the user in the surcharge notification message that was selected via the SURCHARGE OPTIONS SCREEN function. Press the SURCHARGE AMOUNT menu key. The ENTER NEW AMOUNT AND PRESS 'OK' prompt will appear. Enter a new value. This value will appear in the "AMOUNT = \_ \_ \_ \_ \_" field that will appear on the SURCHARGE MODE screen. The value will be stored in the terminal and displayed to the customer in the surcharge notification message. See **ERROR CONDITIONS:** for additional information on this feature.

**ERROR CONDITIONS:**

It is important to understand that processor or network rules and/or applicable commerce laws ultimately determine the type and amount of any surcharge that may be assessed against a transaction. The surcharge values that you enter will be displayed to the customer and **MUST** match the actual surcharge rates established by your processor or other applicable regulatory agencies!

Manually changing the SURCHARGE AMOUNT to a lower or higher amount does not automatically change the surcharge collected by the processor for a transaction. It will only change the surcharge amount displayed during the surcharge-warning message when it is shown to the customer and not the actual fee collected for the transaction.

Compliments of: [www.atndepot.com](http://www.atndepot.com)

## SECTION 5 - MANAGEMENT FUNCTIONS

**FUNCTION: CASSETTE SETUP**

**FACTORY DEFAULT: N/A**

- 1.) Select TERMINAL CONFIGURATION from the MANAGEMENT FUNCTIONS menu.
- 2.) Select SET TERMINAL PARAMETERS.
- 3.) Select CASSETTE SETUP.

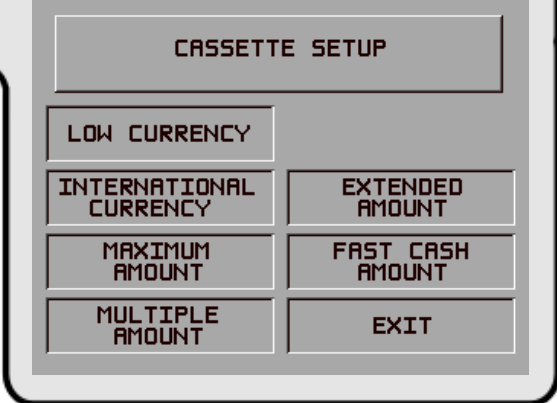
**DESCRIPTION:**

Selecting CASSETTE SETUP at the TERMINAL PARAMETERS menu allows the terminal operator to view and change the following parameters:

- 1.) LOW CURRENCY
- 2.) INTERNATIONAL CURRENCY
- 3.) MAXIMUM AMOUNT
- 4.) MULTIPLE AMOUNT
- 5.) EXTENDED AMOUNT
- 6.) FAST CASH AMOUNT

**ERROR CONDITIONS:**

There are no errors directly associated with the CASSETTE SETUP function.



## SECTION 5 - MANAGEMENT FUNCTIONS

**FUNCTION: LOW CURRENCY**

**FACTORY DEFAULT: ENABLED**

**ACCESS INSTRUCTIONS:**

- 1.) Select **TERMINAL CONFIGURATION** from the **MANAGEMENT FUNCTIONS** menu.
- 2.) Select **SET TERMINAL PARAMETERS**.
- 3.) Select **CASSETTE SETUP**.
- 4.) Choose the **LOW CURRENCY** option.

LOW CURRENCY CHECKING IS:

ENABLED

ENABLED

DISABLED

EXIT

**DESCRIPTION:**

This function is used to enable or disable low currency checking on the dispenser mechanism. If **LOW CURRENCY CHECKING** is **ENABLED**, the Cash Dispenser will go out of service (it will display an **ERROR 182**) when the cash cassette gets down to approximately 60 notes. Enabling **LOW CURRENCY CHECKING** will prevent the need for reversals because there will never be a partial dispense.

If **LOW CURRENCY CHECKING** is **DISABLED**, the Cash Dispenser will not go out of service until the cassette is completely empty. This may result in the need to reverse the last withdrawal due to a partial dispense occurring. In the event of a partial dispense, or no dispense, the terminal will automatically inform the Processor and the customers account will be correctly credited. The record of the successful reversal will be recorded in the journal record.

**ERROR CONDITIONS:**

When the cassette runs out of money during a dispense operation an Error Code 33 (feed failure) will be displayed and the terminal will go out of service. If the error condition is reset with less than about 1/2" to 3/4" of bills in the cassette an error code 182 will be displayed (even with **LOW CURRENCY CHECKING** disabled). To avoid this the Cash Dispenser must be reset with the cassette out of the dispenser, or more than 60 bills must be loaded into the cassette.

**\*\*NOTE\*\***

If the cassette runs out of currency during a dispense, the terminal will generate another call to the processor to reverse the amount not dispensed. Do not reset or turn off the terminal during this call. Doing so will cause the reversal to fail and result in an out of balance condition.

Compliments of: [www.atmdepot.com](http://www.atmdepot.com)

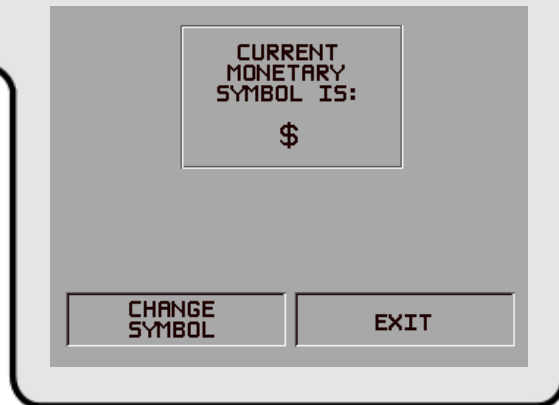
## SECTION 5 - MANAGEMENT FUNCTIONS

### FUNCTION: INTERNATIONAL CURRENCY

#### FACTORY DEFAULT: COUNTRY-SPECIFIC

#### ACCESS INSTRUCTIONS:

- 1.) Select TERMINAL CONFIGURATION from the MANAGEMENT FUNCTIONS menu.
- 2.) Select SET TERMINAL PARAMETERS.
- 3.) Select CASSETTE SETUP.
- 4.) Choose the INTERNATIONAL CURRENCY option.



#### DESCRIPTION:

This feature will allow operator personnel to select one of nine possible monetary symbols (C, ¢, \$, f, L, P<sub>t</sub>, £, Q, ¥) that describe the type of currency that will be dispensed by the Cash Dispenser. The default symbol can be viewed and changed through the terminals' Management Functions.

Monetary symbols for use with following currencies are supported by the Cash Dispenser:

1. C - The symbol for the Colon (Costa Rica)
2. ¢ - The symbol for the Colon (El Salvador)
3. \$ - The symbol of the Dollar and Peso
4. f - The symbol for the Franc
5. L - The symbol for the Lempira
6. P<sub>t</sub> - The symbol for the Peseta
7. £ - The symbol for the Pound
8. Q - The symbol for the Quetzal
9. R - The symbol for the Rand (South Africa)
10. ¥ - The symbol for the Yen

When the INTERNATIONAL CURRENCY menu is displayed, press the screen key next to the CHANGE SYMBOL option until the desired currency symbol is displayed. Press EXIT to make that symbol the default symbol displayed on the terminal.

#### ERROR CONDITIONS:

There are no error conditions directly associated with this function.

## SECTION 5 - MANAGEMENT FUNCTIONS

**FUNCTION: MAXIMUM AMOUNT**

**FACTORY DEFAULT: '\$500.00'**

**ACCESS INSTRUCTIONS:**

- 1.) Select TERMINAL CONFIGURATION from the MANAGEMENT FUNCTIONS menu.
- 2.) Select SET TERMINAL PARAMETERS.
- 3.) Select CASSETTE SETUP.
- 4.) Choose the MAXIMUM AMOUNT option.

**DESCRIPTION:**

The maximum cash withdrawal limit must be set in the Cash Dispenser before any transactions can be completed. This number is the largest dollar amount allowed for a withdrawal transaction. It can be set from 1 to 999999 in increments of 1 and it must be an even multiple of the denomination that is in the cassette. Factory default is set to **\$500.00**. The value is dollar amount only; no cents are allowed.

Whenever a withdrawal amount is entered or selected (via the FAST CASH option), the amount entered or selected is compared to this amount. If the entry is larger, an error message warns the user and displays the maximum allowable amount.

This amount DOES NOT override any maximum set by a network. The transaction will be sent to the network if the amount entered or selected is less than or equal to the maximum. *The network must still approve the amount.*

**ERROR CONDITIONS:**

The MAXIMUM AMOUNT cannot be more than **50 times** the MULTIPLE AMOUNT.

MAXIMUM WITHDRAW LIMIT

\$        . 00

ENTER NEW AMOUNT & PRESS 'OK'

CHANGE

EXIT

Compliments of: [www.atndepot.com](http://www.atndepot.com)

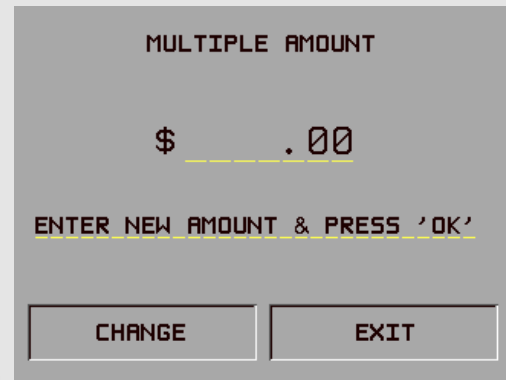
## SECTION 5 - MANAGEMENT FUNCTIONS

### FUNCTION: MULTIPLE AMOUNT

**FACTORY DEFAULT:** '\$0.00'

#### ACCESS INSTRUCTIONS:

- 1.) Select TERMINAL CONFIGURATION from the MANAGEMENT FUNCTIONS menu.
- 2.) Select SET TERMINAL PARAMETERS.
- 3.) Select CASSETTE SETUP.
- 4.) Choose the MULTIPLE AMOUNT option.



#### DESCRIPTION:

The MULTIPLE AMOUNT must be set in the Cash Dispenser before any transactions can be processed. This number is the denomination of the currency installed in the currency cassette. It can be set to any value, *as long as this value is no less than 1/50th of the MAXIMUM AMOUNT*. Typical values might be 10, 20, 50, or 100.

Whenever a withdrawal transaction is performed, the amount entered or selected is compared to the MULTIPLE AMOUNT. If the entry is not a even multiple of this amount, an error warns the terminal user and displays the current multiple amount.

#### ERROR CONDITIONS:

If the MULTIPLE AMOUNT is not set correctly, the terminal will respond by going into Configuration Error 186, BILL SIZE NOT CONFIGURED CORRECTLY. To correct the error condition enter the management functions and configure the bill size (MULTIPLE AMOUNT) to the size of the bill in the cassette.



## SECTION 5 - MANAGEMENT FUNCTIONS

**FUNCTION: EXTENDED AMOUNT**

**FACTORY DEFAULT: DISABLED**

**ACCESS INSTRUCTIONS:**

- 1.) Select TERMINAL CONFIGURATION from the MANAGEMENT FUNCTIONS menu.
- 2.) Select SET TERMINAL PARAMETERS.
- 3.) Select CASSETTE SETUP.
- 4.) Choose the EXTENDED AMOUNT option.

**DESCRIPTION:**

The standard length of a currency amount entry field is 8 digits. In some applications this length is insufficient to allow the entry of the full range of customer transaction values in the local currency type. This feature allows the selection of 12-digit currency fields for those applications that require it.

To activate 12-digit field lengths, select the ENABLE option. To return to 8-digit field lengths, choose the DISABLE option.

**ERROR CONDITIONS:**

There are no error conditions directly associated with this function.

ENABLING THE EXTENDED AMOUNT WILL INCREASE THE TRANSFER FIELD FROM 8 TO 12 DIGITS.

**CAUTION**

ONLY USE THE EXTENDED AMOUNT IF YOUR PROCESSOR CAN ACCEPT THIS PROTOCOL.

EXTENDED AMOUNTS ARE: **DISABLED**

ENABLE

DISABLE

EXIT

Compliments of: [www.atndepot.com](http://www.atndepot.com)

## SECTION 5 - MANAGEMENT FUNCTIONS

### FUNCTION: FAST CASH AMOUNT

#### FACTORY DEFAULT: PROCESSOR-SPECIFIC

#### ACCESS INSTRUCTIONS:

- 1.) Select TERMINAL CONFIGURATION from the MANAGEMENT FUNCTIONS menu.
- 2.) Select SET TERMINAL PARAMETERS.
- 3.) Select CASSETTE SETUP.
- 4.) Choose the FAST CASH AMOUNT option.

FAST CASH SCREEN AMOUNTS	
SELECT AMOUNT TO BE CHANGED	
-----	
\$	
-----	
\$ 0.00	\$ 0.00
\$ 0.00	\$ 0.00
\$ 0.00	EXIT

#### DESCRIPTION:

During a withdrawal transaction the FAST CASH screen prompts the customer to select the amount of the withdrawal from a list of five convenient amounts. These amounts are entered by the terminal operator using the FAST CASH AMOUNT function. Up to six digits (more with software versions that support extended field lengths) can be entered into any data field accepting a monetary value.

Selecting this function displays the FAST CASH SCREEN AMOUNTS screen. Press the screen key next to the amount to be changed, and it will begin to blink. Enter the new amount (whole dollar amount only), and then press the <OK> key. The value will replace the blinking amount.

The amounts entered must be even multiples of the denomination in the cassette. The amounts do not have to be in any particular order, although typically, they increase in value moving from upper left and down, then upper right and down. *DO NOT enter an amount that is larger than the MAXIMUM WITHDRAWAL AMOUNT.*

#### ERROR CONDITIONS:

There are no error conditions directly associated with this function.

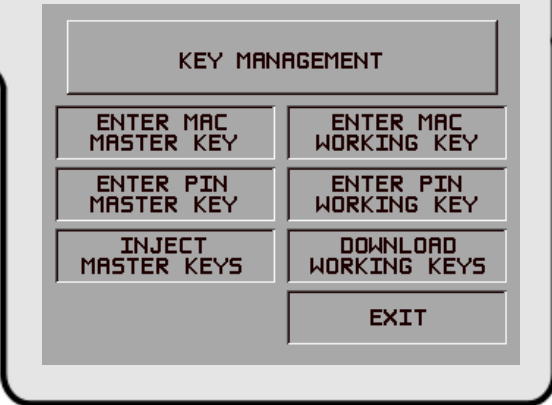
## SECTION 5 - MANAGEMENT FUNCTIONS

**FUNCTION: KEY MANAGEMENT**

**FACTORY DEFAULT: N/A**

**ACCESS INSTRUCTIONS:**

- 1.) Select TERMINAL CONFIGURATION from the MANAGEMENT FUNCTIONS menu.
- 2.) Select SET TERMINAL PARAMETERS.
- 3.) Choose the KEY MANAGEMENT option.



**DESCRIPTION:**

The KEY MANAGEMENT function provides access to Cash Dispenser functions that control the method of entry for the Master Key and the Comms (Communications) Key. The functions accessed through this menu are listed below:

- 1.) ENTER MAC MASTER KEY
- 2.) ENTER PIN MASTER KEY
- 3.) INJECT MASTER KEYS
- 4.) ENTER MAC WORKING KEY
- 5.) ENTER PIN WORKING KEY
- 6.) DOWNLOAD WORKING KEYS

**ERROR CONDITIONS:**

**IMPORTANT:** The MAC MASTER KEY must be entered before the MAC Working key. Likewise, the PIN MASTER KEY must be entered before the PIN Working key.

Compliments of: [www.atndepot.com](http://www.atndepot.com)

## SECTION 5 - MANAGEMENT FUNCTIONS

### FUNCTION: ENTER MAC MASTER KEY

#### FACTORY DEFAULT: PROCESSOR-SPECIFIC

#### ACCESS INSTRUCTIONS:

- 1.) Select TERMINAL CONFIGURATION from the MANAGEMENT FUNCTIONS menu.
- 2.) Select SET TERMINAL PARAMETERS.
- 3.) Select KEY MANAGEMENT.
- 4.) Choose the ENTER MAC MASTER KEY option.

ENTER 16 CHARACTER MAC MASTER  
KEY, THEN PRESS OK

RE-ENTER MAC MASTER KEY.

#### DESCRIPTION:

**NOTE:** The MAC MASTER KEY feature is applicable only to terminals using Triton Standard ATM software and a Secure Pin Entry Device (SPED) module.

**IMPORTANT:** The MAC MASTER KEY must be entered before the MAC Working key.

MAC is an acronym for Message Authentication Code. The MAC MASTER KEY is used to protect the MAC WORKING KEY during manual entry or downloading of the working key. The MAC MASTER KEY is a 16-character string, consisting of the digits 0-9 and the letters A-F. Your processor must provide you with the MAC MASTER KEY. If a MAC authentication attempt on a message fails, the message will fail. This is a security precaution.

For security reasons, when entering this key, a '\*' is displayed in place of the actual character. Since it is not possible to view the key while it is entered, the key must be entered twice to make sure it was entered properly.

To enter a digit 0-9, simply press the key that has that digit, and a '\*' will appear. To enter the letters A-F, first press the <BLUE> key, then press the key that has the letter you want on it. The first press of the key will display the first character above the number. Subsequent presses will display the characters in sequence. When the character you want is displayed, press the <RIGHT ARROW> key to 'lock in' the letter. If your next character is a letter, you must press the <BLUE> key again. Press the <CHANGE> key to clear the entry and start over. Press the <LEFT ARROW> key to back up and erase a character.

## SECTION 5 - MANAGEMENT FUNCTIONS

---

Normally, the MAC MASTER KEY contains only one part. However, some keys may contain multiple parts. If this is the case, separate individuals will hold the parts. If your key has multiple parts you must answer the question "ANOTHER KEY PART?", with a YES until all parts are entered.

The CHECK DIGIT that appears after all parts of the MAC MASTER KEY have been entered is similar to the checksum that is used to verify that the data programmed into a memory device such as an EPROM is correct. The CHECK DIGIT can be verified by doing a RECEIPT PRINTER TEST from the DIAGNOSTICS Menu and comparing the MAC MASTER KEY CHECK DIGIT on the printout to the original receipt printout from the initial terminal setup. If the CHECK DIGIT is different from the original, and the terminal is not operating correctly, the MAC MASTER KEY is corrupt and you should contact your service organization for assistance.

### **ERROR CONDITIONS:**

If the MAC MASTER KEY is not entered correctly, no message traffic can take place, so be sure to enter the key accurately. If your second entry of the key does not match the first entry, you will be warned and allowed to start over with the first entry.

## SECTION 5 - MANAGEMENT FUNCTIONS

### FUNCTION: ENTER PIN MASTER KEY

#### FACTORY DEFAULT: PROCESSOR-SPECIFIC

#### ACCESS INSTRUCTIONS:

- 1.) Select TERMINAL CONFIGURATION from the MANAGEMENT FUNCTIONS menu.
- 2.) Select SET TERMINAL PARAMETERS.
- 3.) Select KEY MANAGEMENT.
- 4.) Choose the ENTER PIN MASTER KEY option.

ENTER 16 CHARACTER PIN MASTER  
THEN PRESS OK

RE-ENTER PIN MASTER KEY

#### DESCRIPTION:

**IMPORTANT:** The PIN MASTER KEY must be entered before the PIN Working key.

**NOTE:** The PIN MASTER KEY was referred to as the MASTER KEY in previous versions of ATM software.

The PIN MASTER KEY is used to protect the PIN WORKING KEY during manual entry or downloading of the working key. This key is a 16-character string, consisting of the digits 0-9 and the letters A-F. Your processor must provide you with the PIN MASTER KEY.

For security reasons, when entering this key, a '\*' is displayed in place of the actual character. Since it is not possible to view the key while it is entered, the key must be entered in twice to make sure it was entered properly.

To enter a digit 0-9, simply press the key that has that digit, and a '\*' will appear. To enter the letters A-F, first press the <BLUE> key, then press the key that has the letter you want on it. The first press of the key will display the first character above the number. Subsequent presses will display the characters in sequence. When the character you want is displayed, press the <RIGHT ARROW> key to 'lock in' the letter. If your next character is a letter, you must press the <BLUE> key again. Press the <CHANGE> key to clear the entry and start over. Press the <LEFT ARROW> key to back up and erase a character.

Normally, the PIN MASTER KEY contains only one part. However, some keys may contain multiple parts. If this is the case, separate individuals will hold the parts. If your key has multiple parts you must answer the question "ANOTHER KEY PART?", with a YES until all parts are entered.

## SECTION 5 - MANAGEMENT FUNCTIONS

---

The CHECK DIGIT that appears after all parts of the PIN MASTER KEY have been entered is similar to the checksum that is used to verify that the data programmed into a memory device such as an EPROM is correct. The CHECK DIGIT can be verified by doing a RECEIPT PRINTER TEST from the DIAGNOSTICS Menu and comparing the PIN MASTER KEY CHECK DIGIT on the printout to the original receipt printout from the initial terminal setup. If the CHECK DIGIT is different from the original, and the terminal is not operating correctly, the PIN MASTER KEY is corrupt, and you should contact your service organization for assistance.

### ERROR CONDITIONS:

If the PIN MASTER KEY is not entered correctly, no message traffic can take place, so be sure to enter the key accurately. If your second entry of the key does not match the first entry, you will be warned and allowed to start over with the first entry.

## SECTION 5 - MANAGEMENT FUNCTIONS

### FUNCTION: INJECT MASTER KEYS

**FACTORY DEFAULT: N/A**

**ACCESS INSTRUCTIONS:**

- 1.) Select **TERMINAL CONFIGURATION** from the **MANAGEMENT FUNCTIONS** menu.
- 2.) Select **SET TERMINAL PARAMETERS**.
- 3.) Select **KEY MANAGEMENT**.
- 4.) Choose the **INJECT MASTER KEYS** option.

**DESCRIPTION:**

The **INJECT MASTER KEYS** function is used in conjunction with a PC (Personnel Computer) and a special floppy disk to inject the master keys from the PC into a designated terminal. Selecting **INJECT MASTER KEYS** will cause the terminal to prepare for the load of the master keys from the PC, using a serial data cable.

**ERROR CONDITIONS:**

Do not connect the load port on the Cash Dispenser to the parallel (printer) port of the PC!



WAITING FOR KEY INJECTION

PRESS CANCEL TO QUIT

Compliments of: [www.atmdepot.com](http://www.atmdepot.com)



## SECTION 5 - MANAGEMENT FUNCTIONS

**FUNCTION: ENTER MAC WORKING KEY**

**FACTORY DEFAULT: PROCESSOR-SPECIFIC**

**ACCESS INSTRUCTIONS:**

- 1.) Select **TERMINAL CONFIGURATION** from the **MANAGEMENT FUNCTIONS** menu.
- 2.) Select **SET TERMINAL PARAMETERS**.
- 3.) Select **KEY MANAGEMENT**.
- 4.) Choose the **ENTER MAC WORKING KEY** option.

ENTER 16 CHARACTER MAC WORKING KEY, THEN PRESS 'OK'

RE-ENTER MAC WORKING KEY.

**DESCRIPTION:**

MAC is an acronym for Message Authentication Code. The **MAC WORKING KEY** is used to verify messages to and from the terminal. The **MAC WORKING KEY** is a 16-character string, consisting of the digits 0-9 and the letters A-F. Your processor must provide you with the **MAC WORKING KEY**. If a MAC authentication attempt on a message fails, the message will fail. This is a security precaution.

For security reasons, when entering this key, a '\*' is displayed in place of the actual character. Since it is not possible to view the key while it is entered, the key must be entered twice to make sure it was entered properly.

To enter a digit 0-9, simply press the key that has that digit, and a '\*' will appear. To enter the letters A-F, first press the <BLUE> key, then press the key that has the letter you want on it. The first press of the key will display the first character above the number. Subsequent presses will display the characters in sequence. When the character you want is displayed, press the <RIGHT ARROW> key to 'lock in' the letter. If your next character is a letter, you must press the <BLUE> key again. Press the <CHANGE> key to clear the entry and start over. Press the <LEFT ARROW> key to back up and erase a character.

Normally, the **MAC WORKING KEY** contains only one part. However, some keys may contain multiple parts. If this is the case, separate individuals will hold the parts. If your key has multiple parts you must answer the question "ANOTHER KEY PART?", with a YES until all parts are entered.

Compliments of: [www.atmdepot.com](http://www.atmdepot.com)

## SECTION 5 - MANAGEMENT FUNCTIONS

---

The CHECK DIGIT that appears after all parts of the MAC WORKING KEY have been entered is similar to the checksum that is used to verify that the data programmed into a memory device such as an EPROM is correct. The CHECK DIGIT can be verified by doing a RECEIPT PRINTER TEST from the DIAGNOSTICS Menu and comparing the MAC WORKING KEY CHECK DIGIT on the printout to the original receipt printout from the initial terminal setup. If the CHECK DIGIT is different from the original, and the terminal is not operating correctly, the MAC WORKING KEY is corrupt, and you should contact your service organization for assistance.

### ERROR CONDITIONS:

If the MAC WORKING KEY is not entered correctly, no message traffic can take place, so be sure to enter the key accurately. If your second entry of the key does not match the first entry, you will be warned and allowed to start over with the first entry.

## SECTION 5 - MANAGEMENT FUNCTIONS

### FUNCTION: ENTER PIN WORKING KEY

**FACTORY DEFAULT: PROCESSOR-SPECIFIC**

**ACCESS INSTRUCTIONS:**

- 1.) Select **TERMINAL CONFIGURATION** from the **MANAGEMENT FUNCTIONS** menu.
- 2.) Select **SET TERMINAL PARAMETERS**.
- 3.) Select **KEY MANAGEMENT**.
- 4.) Choose the **ENTER PIN WORKING KEY** option.



ENTER 16 CHARACTER PIN WORKING  
THEN PRESS 'OK'

**RE-ENTER PIN WORKING KEY**

**DESCRIPTION:**

**NOTE: The PIN WORKING KEY was referred to as the COMMS KEY in previous versions of ATM software.**

The PIN WORKING KEY is used to verify the customer Personal Identification Number during live transactions. This key is a 16-character string, consisting of the digits 0-9 and the letters A-F. Your processor must provide you with the PIN WORKING KEY.

For security reasons, when entering this key, a '\*' is displayed in place of the actual character. Since it is not possible to view the key while it is entered, the key must be entered in twice to make sure it was entered properly.

To enter a digit 0-9, simply press the key that has that digit, and a '\*' will appear. To enter the letters A-F, first press the <BLUE> key, then press the key that has the letter you want on it. The first press of the key will display the first character above the number. Subsequent presses will display the characters in sequence. When the character you want is displayed, press the <RIGHT ARROW> key to 'lock in' the letter. If your next character is a letter, you must press the <BLUE> key again. Press the <CHANGE> key to clear the entry and start over. Press the <LEFT ARROW> key to back up and erase a character.

Normally, the PIN WORKING KEY contains only one part. However, some keys may contain multiple parts. If this is the case, separate individuals will hold the parts. If your key has multiple parts you must answer the question "ANOTHER KEY PART?", with a YES until all parts are entered.

Compliments of: [www.atmdepot.com](http://www.atmdepot.com)

## SECTION 5 - MANAGEMENT FUNCTIONS

---

The CHECK DIGIT that appears after all parts of the PIN WORKING KEY have been entered is similar to the checksum that is used to verify that the data programmed into a memory device such as an EPROM is correct. The CHECK DIGIT can be verified by doing a RECEIPT PRINTER TEST from the DIAGNOSTICS Menu and comparing the PIN WORKING KEY CHECK DIGIT on the printout to the original receipt printout from the initial terminal setup. If the CHECK DIGIT is different from the original, and the terminal is not operating correctly, the PIN WORKING KEY is corrupt, and you should contact your service organization for assistance.

### ERROR CONDITIONS:

If the PIN WORKING KEY is not entered correctly, no message traffic can take place, so be sure to enter the key accurately. If your second entry of the key does not match the first entry, you will be warned and allowed to start over with the first entry.

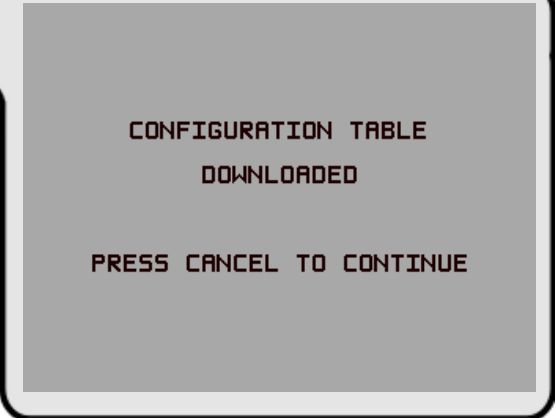
## SECTION 5 - MANAGEMENT FUNCTIONS

**FUNCTION: DOWNLOAD WORKING KEYS**

**FACTORY DEFAULT: PROCESSOR-SPECIFIC**

**ACCESS INSTRUCTIONS:**

- 1.) Select **TERMINAL CONFIGURATION** from the **MANAGEMENT FUNCTIONS** menu.
- 2.) Select **SET TERMINAL PARAMETERS**.
- 3.) Select **KEY MANAGEMENT**.
- 4.) Choose the **DOWNLOAD WORKING KEYS** option.



CONFIGURATION TABLE  
DOWNLOADED  
  
PRESS CANCEL TO CONTINUE

**DESCRIPTION:**

The **WORKING KEYS** are the **MAC** and **PIN WORKING KEYS**, as described earlier. They are made up of 16-character strings, consisting of the digits 0-9 and the letters A-F. Your processor may provide you with the **WORKING KEYS**, or they may be downloaded from the processor host computer.

These keys must be loaded before the Cash Dispenser can operate in a live mode.

When the **DOWNLOAD WORKING KEYS** function is run, a call is placed to your host computer, and a request is made for the keys to be sent. The host will send the keys and several other parameters (such as the surcharge amount, if applicable). Once downloaded, these parameters will remain in the Cash Dispenser, even if it is turned off.

The **TERMINAL NUMBER** and **PRIMARY PHONE NUMBER** must be set before completing this function. If they are not set correctly, the **WORKING KEYS** will not be downloaded.

**ERROR CONDITIONS:**

If the call cannot be completed, a warning screen will be displayed. If the function continues to fail, contact your service organization for assistance.

Compliments of: [www.atmdepot.com](http://www.atmdepot.com)


## SECTION 5 - MANAGEMENT FUNCTIONS

**FUNCTION: TELEPHONE**

**FACTORY DEFAULT: N/A**

**ACCESS INSTRUCTIONS:**

- 1.) Select TERMINAL CONFIGURATION from the MANAGEMENT FUNCTIONS menu.
- 2.) Select SET TERMINAL PARAMETERS.
- 3.) Select TELEPHONE.



### DESCRIPTION:

The TELEPHONE function is used to set up parameters that control telephone communications between the Cash Dispenser and the Processor. The following parameters are accessed through this function.

- 1.) PRIMARY NUMBER
- 2.) BACKUP NUMBER
- 3.) DATAPAK ACCESS CODE (This feature is only available for ATMs deployed in Canada.)
- 4.) PREDIAL ON/OFF
- 5.) COMPUSERVE ID
- 6.) MODEM SETUP

### ERROR CONDITIONS:

There are no error conditions directly associated with this function.

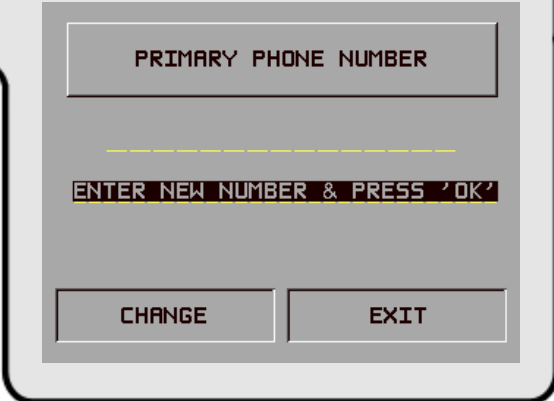
## SECTION 5 - MANAGEMENT FUNCTIONS

**FUNCTION: PRIMARY NUMBER**

**FACTORY DEFAULT: NONE**

**ACCESS INSTRUCTIONS:**

- 1.) Select **TERMINAL CONFIGURATION** from the **MANAGEMENT FUNCTIONS** menu.
- 2.) Select **SET TERMINAL PARAMETERS**.
- 3.) Select **TELEPHONE**.
- 4.) Select the **PRIMARY NUMBER** option.



**DESCRIPTION:**

The Cash Dispenser communicates to your host processor over a dial up phone line. The phone number of the processor must be entered before live transactions can be performed.

When this function is selected, the current phone number is displayed (if nothing appears on the screen, no number is set). Select **CHANGE** to blank the current entry, and then enter the desired phone number. The phone number may be up to 30 digits long. It can also contain a dialing prefix, such as a '9' for an outside line, if necessary. If you need to pause after the prefix, place a comma in the number for a two-second delay at that point. Pressing the <BLUE> key first, then the <0> key, followed by the <RIGHT ARROW> key will select the comma character. Make sure to enter the long distance prefix '1' if you are dialing an 800 number or a toll long distance number. Do not enter dashes in the number.

**ERROR CONDITIONS:**

The Cash Dispenser will not process transactions if the phone number has not been entered or has been entered incorrectly. In such cases error code **"185 - Phone Number Not Configured"**, will be received.

Compliments of: [www.atmdepot.com](http://www.atmdepot.com)

## SECTION 5 - MANAGEMENT FUNCTIONS

**FUNCTION: BACKUP NUMBER**

**FACTORY DEFAULT: NONE**

**ACCESS INSTRUCTIONS:**

- 1.) Select TERMINAL CONFIGURATION from the MANAGEMENT FUNCTIONS menu.
- 2.) Select SET TERMINAL PARAMETERS.
- 3.) Select TELEPHONE.
- 4.) Select the BACKUP NUMBER option.

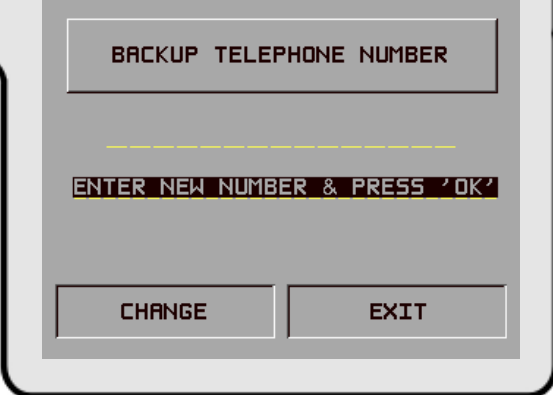
**DESCRIPTION:**

The Cash Dispenser communicates with your Processors' host computer over a dial up phone line. Some processors allow a backup phone number to try if the primary number fails to connect.

When this function is selected, the current phone number is displayed (if nothing appears on the screen, no number is set). Select CHANGE to blank the current entry, and then enter the desired phone number. The phone number may be up to 30 digits long. It can also contain a dialing prefix, such as a '9' for an outside line, if necessary. If you need to pause after the prefix, place a comma in the number for a two-second delay at that point. Pressing the <BLUE> key first, then the <0> key, followed by the <RIGHT ARROW> select the comma. Make sure to enter the long distance prefix '1' if you are dialing an 800 number or a toll long distance number. Do not enter dashes in the number.

**ERROR CONDITIONS:**

There are no error conditions directly associated with this function.





## SECTION 5 - MANAGEMENT FUNCTIONS

**FUNCTION: DATAPAK ACCESS CODE**

**FACTORY DEFAULT: OFF**

**ACCESS INSTRUCTIONS:**

- 1.) Select TERMINAL CONFIGURATION from the MANAGEMENT FUNCTIONS menu.
- 2.) Select SET TERMINAL PARAMETERS.
- 3.) Select TELEPHONE.
- 4.) Select DATAPAK ACCESS CODE.

DATAPAK ACCESS CODE

ENTER NEW ACCESS CODE

---

DATAPAK  
FEATURE    OFF

CHANGE DATAPAK  
ACCESS CODE

EXIT

**DESCRIPTION:**

**NOTE: This feature is only available for the Triton Standard Canadian version of ATM operating software.**

This function allows you to enter the DATAPAK ACCESS CODE, and to turn the DataPak feature On or OFF. The DATAPAK ACCESS CODE is provided by the DataPak processing organization, and is an identification number which enables the DataPak processing organization to correctly identify and route data traffic between the terminal and the transaction processor.

The current state of the DATAPAK ACCESS CODE feature is shown as either ON or OFF in the label on the left-hand side of the display. Press the button next to this label to toggle the state of the feature between ON and OFF.

**IMPORTANT: When using the DATAPAK communications protocol, ensure the terminal's Primary and Backup Telephone Numbers are configured to dial the DataPak processing organization (NOT the transaction processor!).**

**ERROR CONDITIONS:**

If a DATAPAK-based communications network is being used, the DATAPAK ACCESS CODE feature must be turned ON and the code must be entered correctly to enable message traffic between the ATM and the processor to take place.

Compliments of: [www.atmdepot.com](http://www.atmdepot.com)

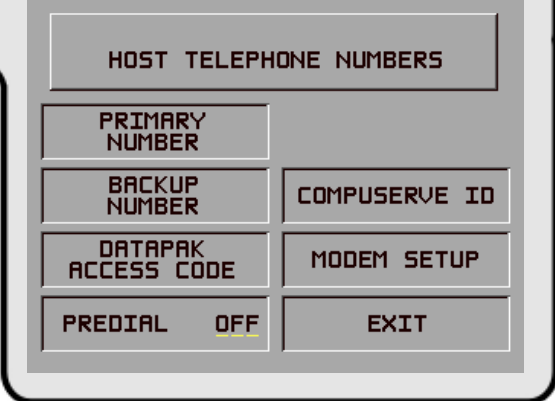
## SECTION 5 - MANAGEMENT FUNCTIONS

**FUNCTION: PREDIAL ON/OFF**

**FACTORY DEFAULT: OFF**

**ACCESS INSTRUCTIONS:**

- 1.) Select **TERMINAL CONFIGURATION** from the **MANAGEMENT FUNCTIONS** menu.
- 2.) Select **SET TERMINAL PARAMETERS**.
- 3.) Select **TELEPHONE**.



HOST TELEPHONE NUMBERS	
PRIMARY NUMBER	
BACKUP NUMBER	COMPUSERVE ID
DATAPAK ACCESS CODE	MODEM SETUP
PREDIAL OFF	EXIT

### DESCRIPTION:

This function allows you to turn on or off the **PREDIAL** feature. When the feature is turned **ON**, the terminal will dial out to the processor and establish a connection as soon as the customer's ATM or credit card has been scanned by the card reader. The purpose of this mode of operation is to provide quicker processing of customer transactions. When the feature is turned **OFF**, the terminal will wait until the customer has selected a particular transaction before dialing out and establishing a connection with the processor.

The current state of the **PREDIAL** feature is shown as either **ON** or **OFF** in the label on the left-hand side of the display. Press the button next to this label to toggle the state of the feature between **ON** and **OFF**.

### ERROR CONDITIONS:

There are no error conditions directly associated with this function.

## SECTION 5 - MANAGEMENT FUNCTIONS

**FUNCTION: COMPUSERVE ID**

**FACTORY DEFAULT: NONE**

**ACCESS INSTRUCTIONS:**

- 1.) Select **TERMINAL CONFIGURATION** from the **MANAGEMENT FUNCTIONS** menu.
- 2.) Select **SET TERMINAL PARAMETERS**.
- 3.) Select **TELEPHONE**.
- 4.) Select the **COMPUSERVE ID** option.

**DESCRIPTION:**

The CompuServe Network is used by some processors to route transactions. The COMPUSERVE ID function allows the terminal operator or a service technician to view and change the COMPUSERVE ROUTING ID number.

**ERROR CONDITIONS:**

When CompuServe is used as the communication media for sending and receiving transaction data to the Processor, an incorrect CompuServe ID will cause communication between the terminal and the Processor to fail. **Never change the COMPUSERVE ID unless instructed to do so by your processor.**

COMPUSERVE ROUTING ID

CHANGE

EXIT

Compliments of: [www.atndepot.com](http://www.atndepot.com)

## SECTION 5 - MANAGEMENT FUNCTIONS

**FUNCTION: MODEM SETUP**

**FACTORY DEFAULT: N/A**

**ACCESS INSTRUCTIONS:**

- 1.) Select TERMINAL CONFIGURATION from the MANAGEMENT FUNCTIONS menu.
- 2.) Select SET TERMINAL PARAMETERS.
- 3.) Select TELEPHONE.
- 4.) Select the MODEM SETUP option.

MODEM CONFIGURATION

DIAL MODE	MODEM SETUP STRING
DIAL RATE	RESET/TEST MODEM
BAUD RATE	EXIT

**DESCRIPTION:**

Selecting the MODEM SETUP OPTION from the TELEPHONE screen allows the terminal operator to select the following parameters:

- 1.) DIAL MODE
- 2.) DIAL RATE
- 3.) BAUD RATE
- 4.) MODEM SETUP STRING
- 5.) RESET/TEST MODEM

**ERROR CONDITIONS:**

There are no error conditions directly associated with this function.

## SECTION 5 - MANAGEMENT FUNCTIONS

**FUNCTION: DIAL MODE**

**FACTORY DEFAULT: 'DTMF'**

**ACCESS INSTRUCTIONS:**

- 1.) Select TERMINAL CONFIGURATION from the MANAGEMENT FUNCTIONS menu.
- 2.) Select SET TERMINAL PARAMETERS.
- 3.) Select TELEPHONE.
- 4.) Select the MODEM SETUP option.
- 5.) Select DIAL MODE.

DIAL MODE

DTMF

DTMF  
( TOUCH-TONE )

PULSE  
( ROTARY )

EXIT

**DESCRIPTION:**

The modem is configured to dial in either the touch-tone mode (DTMF), or in the rotary (PULSE) mode. Consult with the local phone company to determine which option is supported. After selecting the dial mode, be certain to execute the RESET/TEST MODEM function. The new dial mode does not take effect until you do this. The factory default for the function is DTMF.

**ERROR CONDITIONS:**

If the local phone exchange does not support touch-tone, and the terminal is configured for DTMF mode, no calls will be completed. Rotary will work on touch-tone systems, but should not be used if touch-tone is available. Rotary mode will dial much slower than DTMF.

Compliments of: [www.atndepot.com](http://www.atndepot.com)

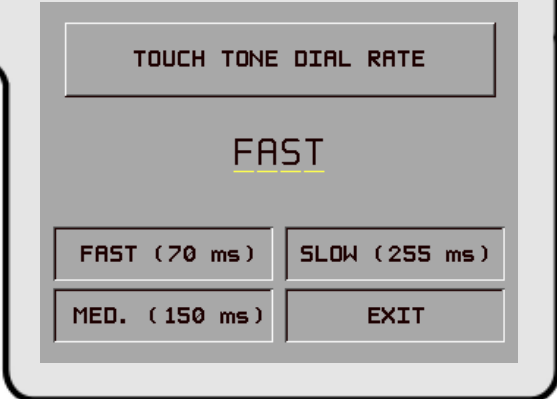
## SECTION 5 - MANAGEMENT FUNCTIONS

**FUNCTION: DIAL RATE**

**FACTORY DEFAULT: 'FAST'**

**ACCESS INSTRUCTIONS:**

- 1.) Select TERMINAL CONFIGURATION from the MANAGEMENT FUNCTIONS menu.
- 2.) Select SET TERMINAL PARAMETERS.
- 3.) Select TELEPHONE.
- 4.) Select the MODEM SETUP option.
- 5.) Select DIAL RATE.



### DESCRIPTION:

The internal modem can be configured to send dial tones at one of three speeds. The possible values are FAST (70 milliseconds), MED. (150 ms), and SLOW (255 ms). The default value from the factory is FAST. After changing the dial rate, be certain to execute the RESET/TEST MODEM function. The new dial rate does not take effect until you do this.

### ERROR CONDITIONS:

There are no error conditions directly associated with this function, but if calls seem to fail, try a slower setting.


## SECTION 5 - MANAGEMENT FUNCTIONS

**FUNCTION: BAUD RATE**

**FACTORY DEFAULT: '1200'**

**ACCESS INSTRUCTIONS:**

- 1.) Select TERMINAL CONFIGURATION from the MANAGEMENT FUNCTIONS menu.
- 2.) Select SET TERMINAL PARAMETERS.
- 3.) Select TELEPHONE.
- 4.) Select the MODEM SETUP option.
- 5.) Select BAUD RATE.



**DESCRIPTION:**

The bit rate of the modem can be controlled with this function. The rate can be set to 2400 or 1200 bits per second (bps). The default rate depends on your processor. Do not select 2400 if your processor does not support it.

**ERROR CONDITIONS:**

If the speed of the modem is set to 2400 bps, it may not connect to a 1200 bps system. The baud rate of the modem should always be set to the value indicated by your processor.

Compliments of: [www.atndepot.com](http://www.atndepot.com)

## SECTION 5 - MANAGEMENT FUNCTIONS

**FUNCTION: MODEM SETUP STRING**

**FACTORY DEFAULT: MODEM-SPECIFIC**

**ACCESS INSTRUCTIONS:**

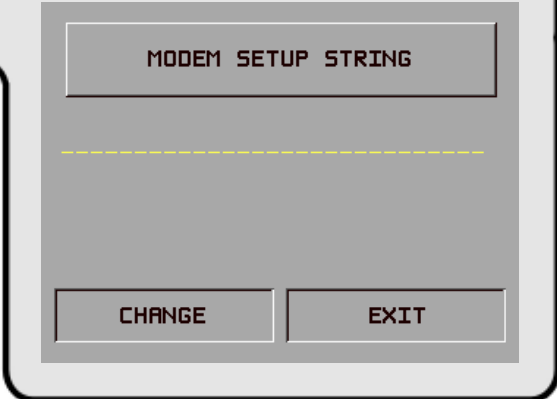
- 1.) Select **TERMINAL CONFIGURATION** from the **MANAGEMENT FUNCTIONS** menu.
- 2.) Select **SET TERMINAL PARAMETERS**.
- 3.) Select **TELEPHONE**.
- 4.) Select the **MODEM SETUP** option.
- 5.) Select **MODEM SETUP STRING**.

**DESCRIPTION:**

If special circumstances require a nonstandard modem configuration, a Hayes-compatible setup string can be sent to the modem when it is initialized.

**ERROR CONDITIONS:**

Setting this value incorrectly will cause communication failure due to improper modem setup. **Consult Triton's Technical Service Department before changing this parameter.**






## SECTION 5 - MANAGEMENT FUNCTIONS

**FUNCTION: RESET/TEST MODEM**

**FACTORY DEFAULT: N/A**

**ACCESS INSTRUCTIONS:**

- 1.) Select **TERMINAL CONFIGURATION** from the **MANAGEMENT FUNCTIONS** menu.
- 2.) Select **SET TERMINAL PARAMETERS**.
- 3.) Select **TELEPHONE**.
- 4.) Select the **MODEM SETUP** option.
- 5.) Select **RESET/TEST MODEM**.



MODEM TESTING / INITIALIZATION  
IN PROGRESS  
PLEASE WAIT

**DESCRIPTION:**

This function is used to reset and test the internal modem. It should be run after setting any of the modem configuration parameters to make sure an error was not made. It **MUST** be run after changing the **DIAL MODE** or **DIAL RATE**, otherwise these new values will not take effect until the unit is turned off and back on again.

At the conclusion of the test a screen will appear indicating that the **MODEM CONFIGURED AND TESTED OK**.

**ERROR CONDITIONS:**

An error message will indicate a problem if the setup string is invalid or the modem is not responding.

Compliments of: [www.atmdepot.com](http://www.atmdepot.com)

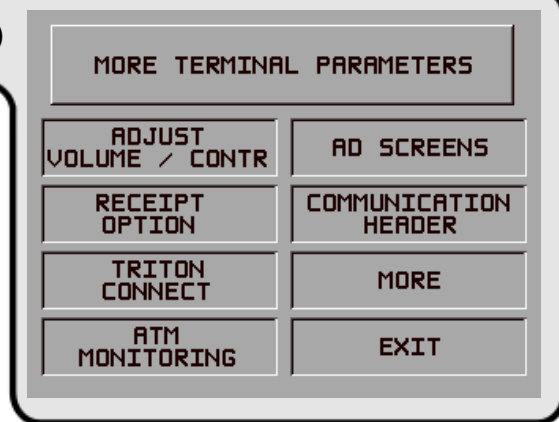
## SECTION 5 - MANAGEMENT FUNCTIONS

**FUNCTION: MORE (TERMINAL PARAMETERS)**

**FACTORY DEFAULT: N/A**

**ACCESS INSTRUCTIONS:**

- 1.) Select TERMINAL CONFIGURATION from the MANAGEMENT FUNCTIONS menu.
- 2.) Select SET TERMINAL PARAMETERS.
- 3.) Choose MORE.



**DESCRIPTION:**

Selecting the MORE TERMINAL PARAMETERS option from the TERMINAL PARAMETERS allows the terminal operator or a service technician to view or change the following:

- 1.) ADJUST VOLUME AND CONTRAST
- 2.) RECEIPT OPTION
- 3.) TRITON CONNECT
- 4.) ATM MONITORING
- 5.) AD SCREENS
- 6.) COMMUNICATION HEADER
- 7.) MORE

**ERROR CONDITIONS:**

There are no error conditions directly associated with this function.

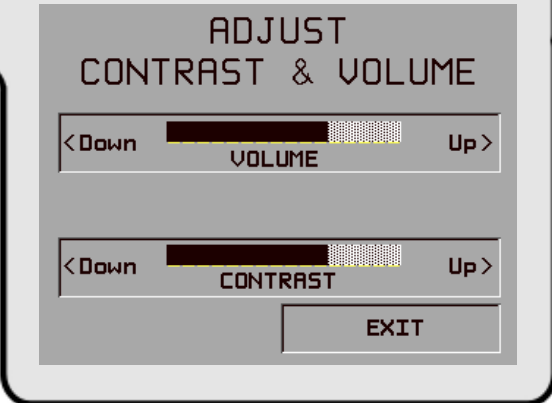
## SECTION 5 - MANAGEMENT FUNCTIONS

**FUNCTION: ADJUST VOLUME/CONTR**

**FACTORY DEFAULT: VOL: Maximum  
CONTRAST: Mid-Range**

**ACCESS INSTRUCTIONS:**

- 1.) Select TERMINAL CONFIGURATION from the MANAGEMENT FUNCTIONS menu.
- 2.) Select SET TERMINAL PARAMETERS.
- 3.) Choose MORE.
- 4.) Choose ADJUST VOLUME/CONTR.



**DESCRIPTION:**

This feature allows the terminal operator to adjust the speaker volume and the contrast of the display.

To adjust the level of the volume of the beeps emanating from the speaker, press the designated UP or DOWN keys next to the display. Change the contrast of the display by selecting the designated UP or DOWN key to set the display contrast for best viewing.

**ERROR CONDITIONS:**

There are no error conditions directly associated with this function.

Compliments of: [www.atndepot.com](http://www.atndepot.com)

## SECTION 5 - MANAGEMENT FUNCTIONS

**FUNCTION: RECEIPT OPTION**

**FACTORY DEFAULT: DISABLED**

**ACCESS INSTRUCTIONS:**

- 1.) Select **TERMINAL CONFIGURATION** from the **MANAGEMENT FUNCTIONS** menu.
- 2.) Select **SET TERMINAL PARAMETERS**.
- 3.) Choose **MORE**.
- 4.) Choose **RECEIPT OPTION**.


**DESCRIPTION:**

This feature allows the customer to select the option of receiving or not receiving a receipt at the completion of a withdrawal transaction. When **RECEIPT OPTION** is **ENABLED** the customer is presented with a message at the conclusion of the transaction asking whether they want a receipt or not. If they respond **NO** to the question, a receipt is not dispensed. If they respond **YES** to the question a receipt is printed. If the customer does not respond to the question, a receipt is automatically printed after a forty-second delay.

If you don't want the customer to have this option, **DISABLE** the **RECEIPT OPTION**. Customers will then receive a receipt after every transaction.

**ERROR CONDITIONS:**

There are no error conditions directly associated with this function.



The screenshot shows a terminal screen with the following text: 'RECEIPT OPTION' at the top, followed by 'DISABLED' which is underlined. Below this are three buttons: 'ENABLED', 'DISABLED', and 'EXIT'.

## SECTION 5 - MANAGEMENT FUNCTIONS

**FUNCTION: TRITON CONNECT**

**FACTORY DEFAULT: DISABLED**

**ACCESS INSTRUCTIONS:**

- 1.) Select TERMINAL CONFIGURATION from the MANAGEMENT FUNCTIONS menu.
- 2.) Select SET TERMINAL PARAMETERS.
- 3.) Choose MORE.
- 4.) Choose TRITON CONNECT.

**DESCRIPTION:**

Selecting the TRITON CONNECT function allows the terminal operator to set up the following parameters associated with Triton Connect:

- 1.) PRIMARY NUMBER
- 2.) BACKUP NUMBER
- 3.) ALARM NUMBERS
- 4.) CALL BACK (ENABLE/DISABLE)
- 5.) TRITON CONNECT (ENABLE/DISABLE)

**NOTE: Triton Connect is an option and may not be installed on your terminal.**

**ERROR CONDITIONS:**

There are no error conditions directly associated with this function.

TRITON CONNECT

TRITON CONNECT IS DISABLED

CALL BACK IS ENABLED

PRIMARY NUMBER	DISABLE CALL BACK
BACKUP NUMBER	ENABLE TRITON CONNECT
ALARM NUMBERS	EXIT

Compliments of: [www.atndepot.com](http://www.atndepot.com)

## SECTION 5 - MANAGEMENT FUNCTIONS

**FUNCTION: PRIMARY NUMBER**

**FACTORY DEFAULT: NONE**

**ACCESS INSTRUCTIONS:**

- 1.) Select TERMINAL CONFIGURATION from the MANAGEMENT FUNCTIONS menu.
- 2.) Select SET TERMINAL PARAMETERS.
- 3.) Choose MORE.
- 4.) Select TRITON CONNECT.
- 5.) Choose PRIMARY NUMBER.

**DESCRIPTION:**

The PRIMARY NUMBER function is used to enter the number that the terminal can use for calling back the Triton Connect Host Computer.

When this function is selected, the current phone number is displayed (if nothing appears on the screen, no number is set). Select CHANGE to blank the current entry, and then enter the desired phone number. The phone number may be up to 30 digits long. It can also contain a dialing prefix, such as a '9' for an outside line, if necessary. If you need to pause after the prefix, place a comma in the number for a two-second delay at that point. Pressing the <BLUE> key first, then the <0> key, followed by the <RIGHT ARROW> key to select the comma character. Make sure to enter the long distance prefix '1' if you are dialing an 800 number or a toll long distance number. Do not enter dashes in the number.

**ERROR CONDITIONS::**

There are no error conditions directly associated with this function.

PRIMARY PHONE NUMBER

---

ENTER NEW NUMBER & PRESS 'OK'

CHANGE

EXIT


## SECTION 5 - MANAGEMENT FUNCTIONS

**FUNCTION: BACKUP NUMBER**

**FACTORY DEFAULT: NONE**

**ACCESS INSTRUCTIONS:**

- 1.) Select TERMINAL CONFIGURATION from the MANAGEMENT FUNCTIONS menu.
- 2.) Select SET TERMINAL PARAMETERS.
- 3.) Choose MORE.
- 4.) Select TRITON CONNECT.
- 5.) Choose BACKUP NUMBER.



**DESCRIPTION:**

The BACKUP NUMBER function is used to enter a backup number that the terminal can use for calling back the Triton Connect computer.

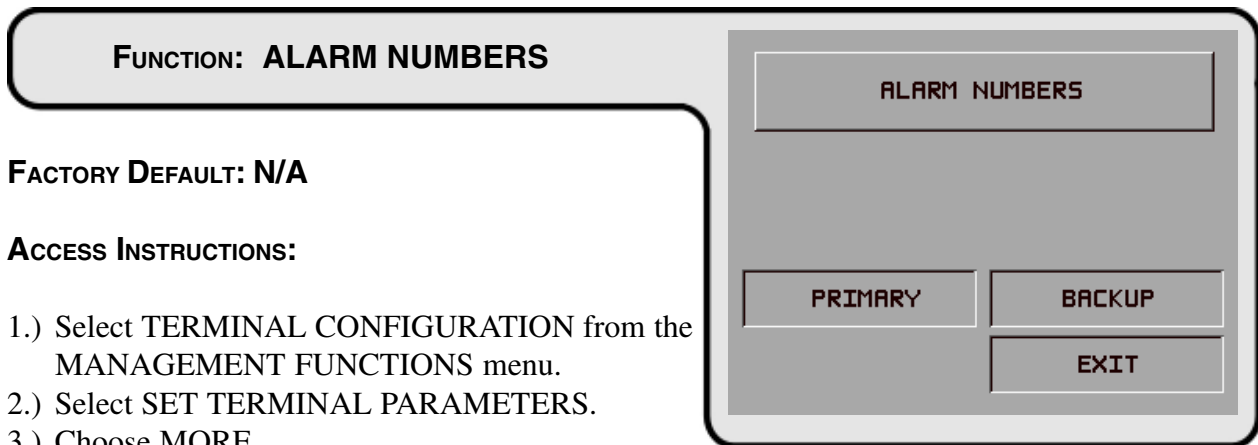
When this function is selected, the current phone number is displayed (if nothing appears on the screen, no number is set). Select CHANGE to blank the current entry, and then enter the desired phone number. The phone number may be up to 30 digits long. It can also contain a dialing prefix, such as a '9' for an outside line, if necessary. If you need to pause after the prefix, place a comma in the number for a two-second delay at that point. Press the <BLUE> key, then the <0> key, followed by the <RIGHT ARROW> key to select the comma character. Make sure to enter the long distance prefix '1' if you are dialing an 800 number or a toll long distance number. Do not enter dashes in the number.

**ERROR CONDITIONS:**

There are no error conditions directly associated with this function.

Compliments of: [www.atndepot.com](http://www.atndepot.com)

## SECTION 5 - MANAGEMENT FUNCTIONS



**FACTORY DEFAULT: N/A**

**ACCESS INSTRUCTIONS:**

- 1.) Select **TERMINAL CONFIGURATION** from the **MANAGEMENT FUNCTIONS** menu.
- 2.) Select **SET TERMINAL PARAMETERS**.
- 3.) Choose **MORE**.
- 4.) Choose **TRITON CONNECT**.
- 5.) Choose **ALARM NUMBERS**.

**DESCRIPTION:**

In some applications the terminal monitoring organization may require different telephone numbers for alarm reporting purposes. This could enable a third party service organization, for example, to be notified of alarm conditions that can occur during non-business hours. Selecting the **ALARM NUMBERS** option brings up a menu that allows the terminal operator to select and configure the Primary and Backup Triton Connect Alarm Numbers.

**NOTE: Triton Connect is an option and may not be installed on your terminal.**

**ERROR CONDITIONS:**

There are no error conditions directly associated with this function.



## SECTION 5 - MANAGEMENT FUNCTIONS

**FUNCTION: PRIMARY ALARM NUMBER**

**FACTORY DEFAULT: NONE**

**ACCESS INSTRUCTIONS:**

- 1.) Select TERMINAL CONFIGURATION from the MANAGEMENT FUNCTIONS menu.
- 2.) Select SET TERMINAL PARAMETERS.
- 3.) Choose MORE.
- 4.) Select TRITON CONNECT.
- 5.) Select ALARM NUMBERS.
- 6.) Choose PRIMARY.

PRIMARY ALARM NUMBER

---

ENTER NEW NUMBER & PRESS 'OK'

CHANGE

EXIT

**DESCRIPTION:**

The PRIMARY ALARM NUMBER function is used to enter the telephone number that the terminal can use for calling a Triton Connect Host Computer to report alarm conditions.

NOTE: If no primary alarm number is entered, the terminal will default to the PRIMARY TRITON CONNECT NUMBER when placing alarm-initiated calls.

When this function is selected, the current phone number is displayed (if nothing appears on the screen, no number is set). Select CHANGE to blank the current entry, and then enter the desired phone number. The phone number may be up to 30 digits long. It can also contain a dialing prefix, such as a '9' for an outside line, if necessary. If you need to pause after the prefix, place a comma in the number for a two-second delay at that point. Pressing the <BLUE> key first, then the <0> key, followed by the <RIGHT ARROW> key to select the comma character. Make sure to enter the long distance prefix '1' if you are dialing an 800 number or a toll long distance number. Do not enter dashes in the number.

**ERROR CONDITIONS::**

There are no error conditions directly associated with this function.

Compliments of: [www.atndepot.com](http://www.atndepot.com)


## SECTION 5 - MANAGEMENT FUNCTIONS

**FUNCTION: BACKUP ALARM NUMBER**

**FACTORY DEFAULT: NONE**

**ACCESS INSTRUCTIONS:**

- 1.) Select TERMINAL CONFIGURATION from the MANAGEMENT FUNCTIONS menu.
- 2.) Select SET TERMINAL PARAMETERS.
- 3.) Choose MORE.
- 4.) Select TRITON CONNECT.
- 5.) Select ALARM NUMBERS.
- 6.) Choose BACKUP.



### DESCRIPTION:

The BACKUP ALARM NUMBER function is used to enter a backup telephone number that the terminal can use for calling a Triton Connect computer to report alarm conditions.

When this function is selected, the current phone number is displayed (if nothing appears on the screen, no number is set). Select CHANGE to blank the current entry, and then enter the desired phone number. The phone number may be up to 30 digits long. It can also contain a dialing prefix, such as a '9' for an outside line, if necessary. If you need to pause after the prefix, place a comma in the number for a two-second delay at that point. Press the <BLUE> key, then the <0> key, followed by the <RIGHT ARROW> key to select the comma character. Make sure to enter the long distance prefix '1' if you are dialing an 800 number or a toll long distance number. Do not enter dashes in the number.

### ERROR CONDITIONS:

There are no error conditions directly associated with this function.

## SECTION 5 - MANAGEMENT FUNCTIONS

### FUNCTION: ENABLE/DISABLE CALL BACK

**FACTORY DEFAULT: ENABLED**

**ACCESS INSTRUCTIONS:**

- 1.) Select **TERMINAL CONFIGURATION** from the **MANAGEMENT FUNCTIONS** menu.
- 2.) Select **SET TERMINAL PARAMETERS**.
- 3.) Choose **MORE**.
- 4.) Select **TRITON CONNECT**.



**DESCRIPTION:**

Normally, when the Triton Connect Host Computer contacts a terminal, it will hang up and wait for the terminal to **CALL BACK**. This is done for security reasons. The **CALL BACK** option allows the terminal operator to enable and disable this feature.

Once you’ve reached the **TRITON CONNECT** screen, the **CALL BACK** button will present an option to reverse the current state of the feature. For example, if **CALL BACK** is currently **ENABLED**, the **CALL BACK** option button will show the **DISABLE CALL BACK** option. Conversely, if **CALL BACK** is currently **DISABLED**, the **CALL BACK** option button will show the **ENABLE CALL BACK** option.

**ERROR CONDITIONS:**

There are no error conditions directly associated with this function.

Compliments of: [www.atndepot.com](http://www.atndepot.com)

## SECTION 5 - MANAGEMENT FUNCTIONS

### FUNCTION: ENABLE/DISABLE TRITON CONNECT

**FACTORY DEFAULT: DISABLED**

#### ACCESS INSTRUCTIONS:

- 1.) Select TERMINAL CONFIGURATION from the MANAGEMENT FUNCTIONS menu.
- 2.) Select SET TERMINAL PARAMETERS.
- 3.) Choose MORE.
- 4.) Select TRITON CONNECT.

TRITON CONNECT	
TRITON CONNECT IS DISABLED	
CALL BACK IS <u>ENABLED</u>	
PRIMARY NUMBER	DISABLE CALL BACK
BACKUP NUMBER	ENABLE TRITON CONNECT
ALARM NUMBERS	EXIT

#### DESCRIPTION:

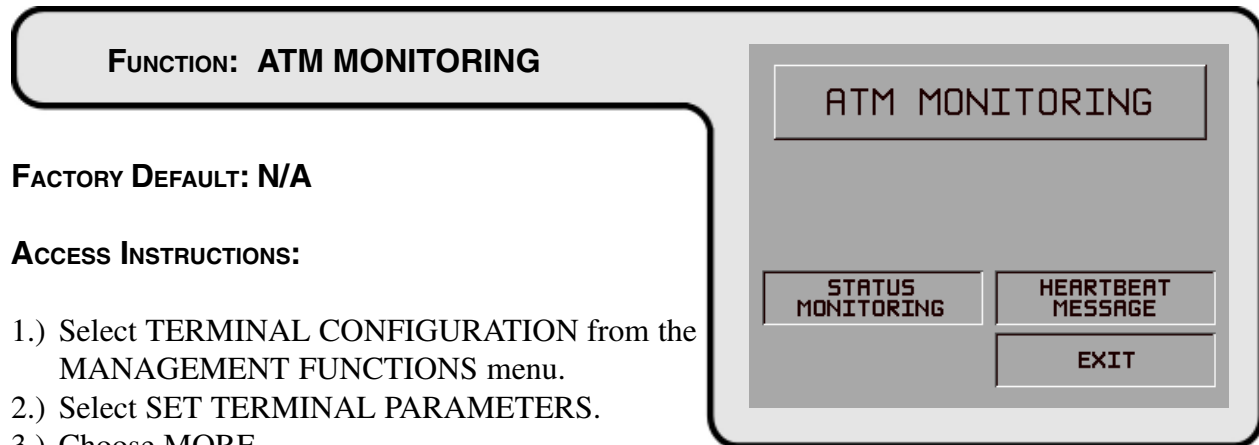
If the Triton Connect feature has been ACTIVATED (using the ACTIVATE function), this function can be used to ENABLE or DISABLE Triton Connect access to the terminal.

Once you've reached the TRITON CONNECT screen, the TRITON CONNECT button will present an option to reverse the current state of this feature. For example, if Triton Connect is currently ENABLED, the button will show the DISABLE TRITON CONNECT option. Conversely, if Triton Connect is currently DISABLED, the option button will show the ENABLE TRITON CONNECT option.

#### ERROR CONDITIONS:

Once Triton Connect is ENABLED, the terminal must be reset to correctly initialize the modem for incoming calls. Also, if the terminal has ever had an error condition it will attempt to report the error to the Triton Connect Host PC shortly after the reset is performed. It is therefore recommended that the Triton Connect Host PC be configured and ready to communicate with the terminal prior to setting up this function.

## SECTION 5 - MANAGEMENT FUNCTIONS



**FACTORY DEFAULT: N/A**

**ACCESS INSTRUCTIONS:**

- 1.) Select TERMINAL CONFIGURATION from the MANAGEMENT FUNCTIONS menu.
- 2.) Select SET TERMINAL PARAMETERS.
- 3.) Choose MORE.
- 4.) Select ATM MONITORING.

**DESCRIPTION:**

The ATM Monitoring screen provides access to the following functions:

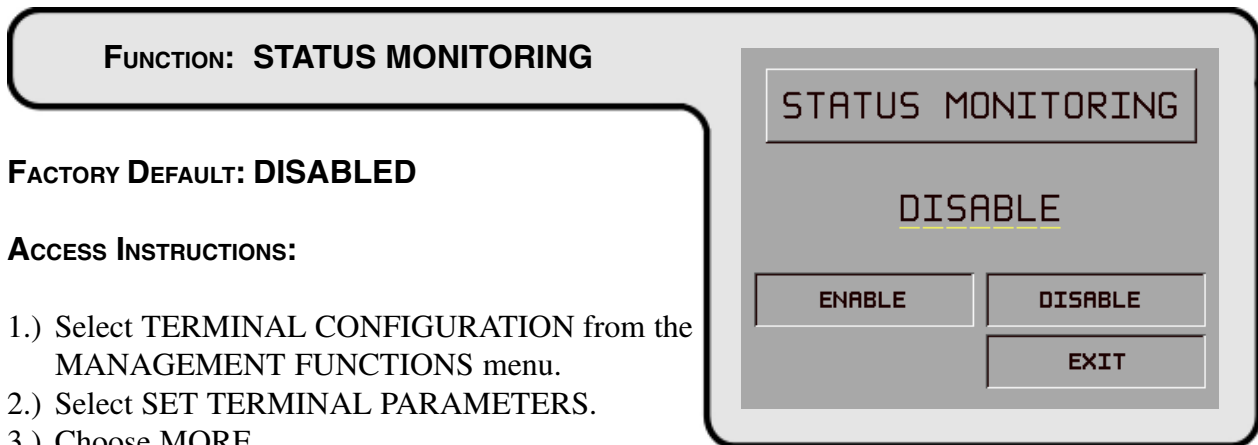
- 1.) STATUS MONITORING. When this feature is enabled the terminal will send operational status information to the processor during the certain transactions. NOTE: This feature must be supported by the processor.
- 2.) HEARTBEAT MESSAGE. The Heartbeat Message feature is designed to provide a means of reporting communications system status to the host processor.

**ERROR CONDITIONS:**

There are no error conditions directly associated with this function.

Compliments of: [www.atmpot.com](http://www.atmpot.com)

## SECTION 5 - MANAGEMENT FUNCTIONS



### FUNCTION: STATUS MONITORING

**FACTORY DEFAULT: DISABLED**

#### ACCESS INSTRUCTIONS:

- 1.) Select TERMINAL CONFIGURATION from the MANAGEMENT FUNCTIONS menu.
- 2.) Select SET TERMINAL PARAMETERS.
- 3.) Choose MORE.
- 4.) Select ATM MONITORING.
- 5.) Select STATUS MONITORING.

#### DESCRIPTION:

STATUS MONITORING is a feature that is available with selected processor software. When enabled the terminal will send operational status information to the processor during certain transactions with the processor. The status information is sent in a data field that is part of any of the following messages sent to the processor:

- 1.) A Transaction Request Message
- 2.) Configuration Table Download Request Message (Comms Key Download)
- 3.) Host Totals Download Request Message
- 4.) Reversal Request Message.

Turn this feature on by selecting the ENABLE option on this screen. Select DISABLE to inhibit the operation of the STATUS MONITORING feature.

#### ERROR CONDITIONS:

There are no error conditions directly associated with this function.

## SECTION 5 - MANAGEMENT FUNCTIONS

**FUNCTION: HEARTBEAT MESSAGE**

**FACTORY DEFAULT: DISABLED**

**ACCESS INSTRUCTIONS:**

- 1.) Select TERMINAL CONFIGURATION from the MANAGEMENT FUNCTIONS menu.
- 2.) Select SET TERMINAL PARAMETERS.
- 3.) Choose MORE.
- 4.) Select ATM MONITORING.
- 5.) Select HEARTBEAT MESSAGE.

**DESCRIPTION:**

The HEARTBEAT MESSAGE feature is designed to provide a means of reporting communications system status to the host processor.

Status reporting by dial-up ATMs is now the norm, but the single most important feature that cannot be monitored is the communications status. The absence of transactions from a particular terminal can mean one of two things. Usually the lack of calls indicates nothing more than a slow period. Sometimes, though, a piece of the communications system will fail and inhibit any calls from being made. The host has no way of determining which scenario is occurring in any kind of real-time mode. The Heartbeat Message overcomes this limitation.

When this feature is ENABLED, the terminal will call the host after a period of inactivity. During this call, the terminal will request a COMMS KEY DOWNLOAD (the normal configuration download request), and will also report status (if the STATUS MONITORING function is ENABLED). This allows the host to determine if a particular terminal is still in operation, even though it may not be performing any transactions at the time. With this feature enabled, the host can finally monitor communications system failures.

The Heartbeat Message feature on the Cash Dispenser has several parameters that must be set to operate properly. These parameters are:

- 1.) HEARTBEAT MESSAGE. This parameter turns on or off the regular call to the host.
- 2.) DELAY PERIOD. This parameter sets the time interval that must expire before a Heartbeat Message will be sent. It is specified in minutes.

HEARTBEAT MESSAGE IS: ENABLED  
AND  
THE DELAY PERIOD IS: \_\_\_ MINUTES

ENABLE	CHANGE DELAY PERIOD
DISABLE	EXIT

Compliments of: [www.atmdepot.com](http://www.atmdepot.com)

## SECTION 5 - MANAGEMENT FUNCTIONS

---

Once the Heartbeat Message call feature is enabled at the terminal, an internal timer will be initialized to the number of minutes set in the DELAY PERIOD parameter at system power-up and after a reset. This timer is restarted each time a call is made to the host. A call to the host is defined as any transaction, including financial, balancing and configuration that actually communicates with the host to the point that the Terminal ID is recognized. A customer transaction that is declined will reset the timer, while a call that fails because the host phone number was busy would not.

It is important to remember that as long as transactions are being done on the terminal on a regular basis, Heartbeat Message calls will not be made. The sole purpose of these calls is to let the host know that the terminal is OK when it is NOT performing regular transactions.

Because the primary purpose of the Heartbeat Message call is to let the host know everything is all right, a Heartbeat Message call that DOES NOT succeed for any reason is not retried. If the call does fail, the interval timer will be reset and the terminal will remain in service.

While the concept of the Heartbeat Message call is simple, interpreting the absence of an expected call must be explained. Listed below are reasons why Heartbeat Message calls will not be received at the host either when expected or at all.

### *Feature Not Turned On*

Obviously, if the feature is not enabled, no Heartbeat Message calls will be made.

### *Terminal is Doing Transactions*

If the terminal does at least one regular customer transaction or balancing transaction before the interval timer, no Heartbeat Message call will be made.

### *Terminal is in Management Function Mode*

Heartbeat Message calls are suspended while the terminal is in the Management mode, although the interval timer continues to run. If the timer expires while the terminal is in this mode, the call will be delayed until the terminal returns to the normal service mode.

### *Terminal is Out of Service*

When the terminal goes out of service, one Heartbeat Message call is made. After that call, all further calls are suspended until it is returned to normal service.



## SECTION 5 - MANAGEMENT FUNCTIONS

---

### *Terminal is Turned Off or Power Has Failed*

If the terminal is turned off, no calls will be made. While an obvious point, it means that for this feature to be of any value, the terminal must always remain on.

### *Communications System Has Failed*

A failure of any piece of the communications system will result in missed calls. This includes the terminal modem, the phone line to the terminal, and any intermediate telecommunications providers.

### *Terminal Was Reset or Power Cycled*

Since the interval timer is reset when the terminal is reset, a scheduled call may not occur at the expected time.

To realize the benefits of the Heartbeat Message, the host must be programmed to monitor the interval between calls from the terminal. It is important to note, though, that the host interval threshold should be set to a value greater than that programmed at the terminal. A practical guideline is at least twice the terminal interval. This allows for Heartbeat Message calls that are delayed because the terminal is in Management mode, or calls skipped because of a system reset.

### **ERROR CONDITIONS:**

There are no error conditions directly associated with this function.

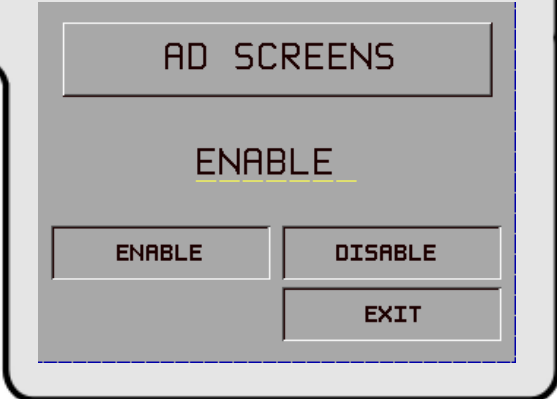
## SECTION 5 - MANAGEMENT FUNCTIONS

**FUNCTION: AD SCREENS**

**FACTORY DEFAULT: ENABLED**

**ACCESS INSTRUCTIONS:**

- 1.) Select **TERMINAL CONFIGURATION** from the **MANAGEMENT FUNCTIONS** menu.
- 2.) Select **SET TERMINAL PARAMETERS**.
- 3.) Choose **MORE**.
- 4.) Select **AD SCREENS**.



The screenshot shows a terminal screen with the following layout: At the top is a box labeled 'AD SCREENS'. Below it is the word 'ENABLE' with a yellow underline. At the bottom are three buttons: 'ENABLE' on the left, 'DISABLE' on the right, and 'EXIT' centered below them.

### DESCRIPTION:

The terminal must have at least one Memory Expansion Card installed for this feature to operate. AD SCREENS is a feature that causes the display on an idle terminal to alternate between the WELCOME SCREEN and a screen containing graphics and text elements used to make an advertisement screen. AD SCREENS are created in a special graphics editor that runs from the Triton Connect Terminal Managers program. The graphics editor lets the user import 16-color bit-mapped graphic files in the '.bmp' format with a maximum resolution of 320 dots by 240 dots. The graphic can then be relocated in the display area. Then text can be added to the display and the graphic and text are saved in the proprietary '.TCG' (Triton Connect Graphic) file format. TCG files can then be downloaded to the terminals' Expansion Memory Card for display on the screen. In addition to the graphic, data is also downloaded that establishes what time of day and for how long the Ad Screen is displayed.

Selecting **ENABLE** from the **AD SCREENS** Menu turns on the **AD SCREENS** feature. Selecting **DISABLE** turns off the feature.

### ERROR CONDITIONS:

There are no error conditions directly associated with this function.

## SECTION 5 - MANAGEMENT FUNCTIONS

**FUNCTION: COMMUNICATION HEADER**

**FACTORY DEFAULT: PROCESSOR-SPECIFIC**

**ACCESS INSTRUCTIONS:**

- 1.) Select TERMINAL CONFIGURATION from the MANAGEMENT FUNCTIONS menu.
- 2.) Select SET TERMINAL PARAMETERS.
- 3.) Choose MORE.
- 3.) Select COMMUNICATION HEADER.

COMMUNICATION HEADER

DISABLED

ENTER NEW HEADER, & PRESS 'OK'

ENABLE	CHANGE
DISABLE	EXIT

**DESCRIPTION:**

The COMMUNICATION HEADER is an optional feature that is only applicable to certain processors. When a specified processor requires the use of the COMMUNICATIONS HEADER it must be ENABLED and have the correct data in the header data field. The COMMUNICATION HEADER data field consists of alphanumeric characters.

To enter a digit 0-9, press the key that has that digit. To enter a letter, first press the <BLUE> key, then press the key that has the letter you want on it. The first press of the key will display the first character above the number. Subsequent presses will display the characters in sequence. When the character you want is displayed, press the <RIGHT ARROW> key to 'lock in' the character. If your next character is a letter, you must press the <BLUE> key again.

**ERROR CONDITIONS:**

Enabling the COMMUNICATION HEADER when using a processor that doesn't use this feature will prevent any type of transaction from completing. Disabling or having incorrect data in the COMMUNICATION HEADER data field (if the feature is required) will also prevent any type of transaction from processing.

Compliments of: [www.atmdepot.com](http://www.atmdepot.com)

## SECTION 5 - MANAGEMENT FUNCTIONS

### FUNCTION: MORE (TERMINAL PARAMETERS)

**FACTORY DEFAULT: N/A**

#### ACCESS INSTRUCTIONS:

- 1.) Select TERMINAL CONFIGURATION from the MANAGEMENT FUNCTIONS menu.
- 2.) Select SET TERMINAL PARAMETERS.
- 3.) Choose MORE.
- 4.) Select MORE.



#### DESCRIPTION:

This screen allows you to select additional terminal parameters functions. The functions available are ALARM THRESHOLDS and VIEW/MODIFY OPTIONS. ALARM THRESHOLDS is used to monitor the status of various parameters (such as number of journal entries, or the level of cash remaining in the cassette), and determines at what point a notification message will be sent to a remote computer. This remote computer must be running Triton Connect monitoring software.

The VIEW/MODIFY OPTIONS function is used to activate or deactivate special terminal features such as Triton Connect.

#### ERROR CONDITIONS:

There are no error conditions directly associated with this function.

## SECTION 5 - MANAGEMENT FUNCTIONS

**FUNCTION: ALARM THRESHOLDS**

**FACTORY DEFAULT: OFF**

**ACCESS INSTRUCTIONS:**

- 1.) Select TERMINAL CONFIGURATION from the MANAGEMENT FUNCTIONS menu.
- 2.) Select SET TERMINAL PARAMETERS.
- 3.) Choose MORE.
- 4.) Select MORE.
- 5.) Select ALARM THRESHOLDS.

**DESCRIPTION:**

This function allows you to turn on or off the LOW CASH THRESHOLD, JOURNAL THRESHOLD, and SCHEDULED JOURNAL features.

- 1.) **LOW CASH THRESHOLD.** When this feature is turned ON, the terminal sends a notification message to a remote Triton Connect computer if the amount of cash in the cassette falls below the level specified using the SET LOW CASH THRESHOLD function. When this feature is turned OFF, no notification message will be sent.
- 2.) **JOURNAL THRESHOLD.** When this feature is turned ON, the terminal will send a notification message to a remote Triton Connect computer if the number of entries in the journal exceeds the level specified using the SET JOURNAL THRESHOLD function. When this feature is turned OFF, no notification message will be sent.
- 3.) **SCHEDULED JOURNAL.** When this feature is turned ON, the terminal will automatically send all journal data to a remote Triton Connect computer at a time established using the SET SCHEDULED JOURNAL function. When this feature is turned OFF, the journal will not be sent automatically.

The current state of each function is shown as either ON or OFF in the applicable label on the left-hand side of the display. Press the button next to the applicable label to toggle the state of the feature between ON and OFF.

**ERROR CONDITIONS:**

There are no error conditions directly associated with this function.

CASH THRESHOLD = \_\_\_\_\_  
 JOURNAL THRESHOLD = \_\_\_\_\_  
 JOURNAL SCHEDULE = \_\_\_\_ :00

LOW CASH THRESHOLD	OFF	SET LOW CASH THRESHOLD
JOURNAL THRESHOLD	OFF	SET JOURNAL THRESHOLD
SCHEDULED JOURNAL	OFF	SET SCHEDULED JOURNAL
EXIT		

Compliments of: [www.atmdepot.com](http://www.atmdepot.com)

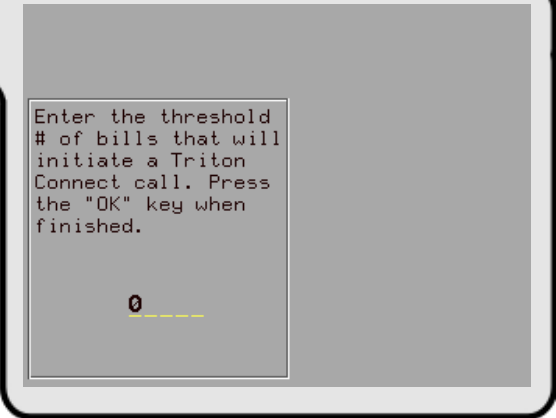
## SECTION 5 - MANAGEMENT FUNCTIONS

### FUNCTION: SET LOW CASH THRESHOLD

**FACTORY DEFAULT: 0**

#### ACCESS INSTRUCTIONS:

- 1.) Select TERMINAL CONFIGURATION from the MANAGEMENT FUNCTIONS menu.
- 2.) Select SET TERMINAL PARAMETERS.
- 3.) Choose MORE.
- 4.) Select MORE.
- 5.) Select ALARM THRESHOLDS.
- 6.) Select SET LOW CASH THRESHOLD.



Enter the threshold  
# of bills that will  
initiate a Triton  
Connect call. Press  
the "OK" key when  
finished.

0

#### DESCRIPTION:

This function allows you to enter the number of bills that will act as a low cash threshold. When the number of bills in the cassette drops below the value set in this function, the terminal will automatically send a notification message to a remote Triton Connect computer.

To ensure the accuracy of the threshold, make sure to use the ENTER QTY. IN CASSETTE function after replenishing the cash in the cassette.

#### ERROR CONDITIONS:

There are no error conditions directly associated with this function.

## SECTION 5 - MANAGEMENT FUNCTIONS

**FUNCTION: SET JOURNAL THRESHOLD**

**FACTORY DEFAULT: 0**

**ACCESS INSTRUCTIONS:**

- 1.) Select TERMINAL CONFIGURATION from the MANAGEMENT FUNCTIONS menu.
- 2.) Select SET TERMINAL PARAMETERS.
- 3.) Choose MORE.
- 4.) Select MORE.
- 5.) Select ALARM THRESHOLDS.
- 6.) Select SET JOURNAL THRESHOLD.

**DESCRIPTION:**

This function allows you to enter the number of journal entries that will act as a threshold. When the number of journal entries rises above the value set in this function, and the Journal Threshold feature is ENABLED, the terminal will automatically contact the remote Triton Connect computer and initiate a transfer of the journal.

**ERROR CONDITIONS:**

IMPORTANT! If the threshold value is set to '0' (zero) while the Journal Threshold feature is ENABLED, no journal will be transmitted!

Enter the threshold # of journal entries that will initiate a Triton Connect call. press the "OK" key when finished.

0

---

Compliments of: [www.atndepot.com](http://www.atndepot.com)

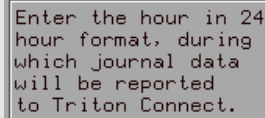
## SECTION 5 - MANAGEMENT FUNCTIONS

### FUNCTION: SET SCHEDULED JOURNAL

**FACTORY DEFAULT: 0**

**ACCESS INSTRUCTIONS:**

- 1.) Select TERMINAL CONFIGURATION from the MANAGEMENT FUNCTIONS menu.
- 2.) Select SET TERMINAL PARAMETERS.
- 3.) Choose MORE.
- 4.) Select MORE.
- 5.) Select ALARM THRESHOLDS.
- 6.) Select SET SCHEDULED JOURNAL.



Enter the hour in 24  
hour format, during  
which journal data  
will be reported  
to Triton Connect.



: 00

**DESCRIPTION:**

This function allows you to enter the time at which the terminal will automatically contact a remote Triton Connect computer and initiate a transfer of the journal.

**ERROR CONDITIONS:**

There are no error conditions directly associated with this function.

Compliments of: [www.atndepot.com](http://www.atndepot.com)



## SECTION 5 - MANAGEMENT FUNCTIONS

**FUNCTION: VIEW/MODIFY OPTIONS**

FEATURE 00

---

IS ACTIVATED

ACTIVATE	SELECT FEATURE NUMBER
DEACTIVATE	EXIT

**FACTORY DEFAULT: N/A**

**ACCESS INSTRUCTIONS:**

- 1.) Select **TERMINAL CONFIGURATION** from the **MANAGEMENT FUNCTIONS** menu.
- 2.) Select **SET TERMINAL PARAMETERS**.
- 3.) Choose **MORE**.
- 4.) Select **MORE**.
- 5.) Select **VIEW/MODIFY OPTIONS**.

**DESCRIPTION:**

The **VIEW/MODIFY OPTIONS FUNCTION** provides access to terminal parameters for setting the following:

- 1.) **ACTIVATE** (A selected feature.)
- 2.) **DEACTIVATE** (A selected feature.)
- 3.) **SELECT FEATURE NUMBER**

**ERROR CONDITIONS:**

There are no error conditions directly associated with this function.

Compliments of: [www.atndepot.com](http://www.atndepot.com)

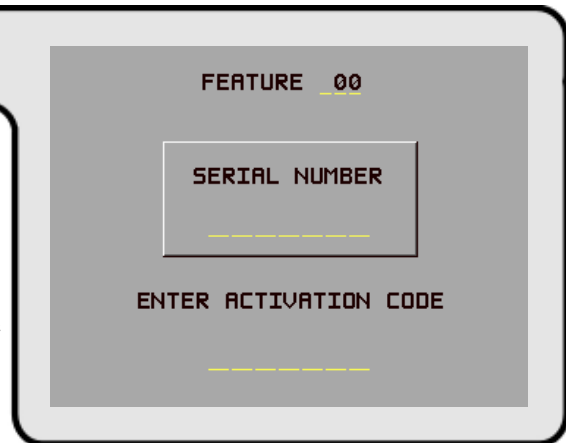
## SECTION 5 - MANAGEMENT FUNCTIONS

### FUNCTION: **ACTIVATE**

**FACTORY DEFAULT: N/A**

#### **ACCESS INSTRUCTIONS:**

- 1.) Select **TERMINAL CONFIGURATION** from the **MANAGEMENT FUNCTIONS** menu.
- 2.) Select **SET TERMINAL PARAMETERS**.
- 3.) Choose **MORE**.
- 4.) Select **MORE**.
- 5.) Select **VIEW/MODIFY OPTIONS**.
- 6.) Choose **ACTIVATE**.



#### **DESCRIPTION:**

To activate a **FEATURE** an activation code must be obtained from the Triton Systems, Inc., Technical Support Department. When calling Triton Systems Inc., you will be asked to provide the serial number that is displayed on the **FEATURE 00 SERIAL NUMBER** screen.

Once the activation code is obtained, select the **ACTIVATE** option from the **FEATURE 00** Menu to display the **FEATURES 00 SERIAL NUMBER** screen. Enter the activation code into the terminal while the **FEATURE 00 SERIAL NUMBER** screen is displayed. Press **<OK>**. If the activation code is correct, a screen informing you that the terminal must be reset to activate the feature is displayed. Reset the terminal by depressing the **RESET** switch on the card cage or cycling the Main Power Switch on the Power Supply from **ON** to **OFF** to **ON**.

If the activation code is entered incorrectly, the terminal will beep 4 times and return to the **FEATURE 00** Menu.

#### **ERROR CONDITIONS:**

There are no error conditions directly associated with this function.

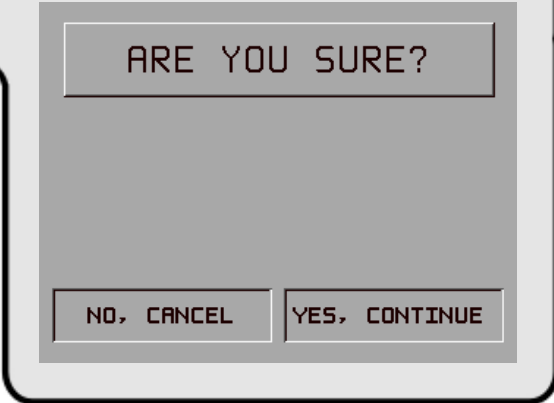
## SECTION 5 - MANAGEMENT FUNCTIONS

**FUNCTION: DEACTIVATE**

**FACTORY DEFAULT: N/A**

**ACCESS INSTRUCTIONS:**

- 1.) Select TERMINAL CONFIGURATION from the MANAGEMENT FUNCTIONS menu.
- 2.) Select SET TERMINAL PARAMETERS.
- 3.) Choose MORE.
- 4.) Select MORE.
- 5.) Select VIEW/MODIFY OPTIONS.
- 6.) Choose DEACTIVATE.



**DESCRIPTION:**

To DEACTIVATE a Feature (such as Feature 00 - Triton Connect), select the DEACTIVATE option from the FEATURE menu. When DEACTIVATE is selected a confirmation screen (“ARE YOU SURE?”) is displayed. Select YES, CONTINUE on the confirmation screen and the FEATURE Menu will be displayed indicating the Feature “IS NOT ACTIVE” .

Selecting the NO, CANCEL option when “ARE YOU SURE?” is displayed will return the display to the FEATURE main menu.

**ERROR CONDITIONS:**

There are no error conditions directly associated with this function.

Compliments of: [www.atndepot.com](http://www.atndepot.com)

## SECTION 5 - MANAGEMENT FUNCTIONS

### FUNCTION: SELECT FEATURE NUMBER

**FACTORY DEFAULT: N/A**

#### ACCESS INSTRUCTIONS:

- 1.) Select TERMINAL CONFIGURATION from the MANAGEMENT FUNCTIONS menu.
- 2.) Select SET TERMINAL PARAMETERS.
- 3.) Choose MORE.
- 4.) Select MORE.
- 5.) Select VIEW/MODIFY OPTIONS.
- 6.) Choose SELECT FEATURE NUMBER.



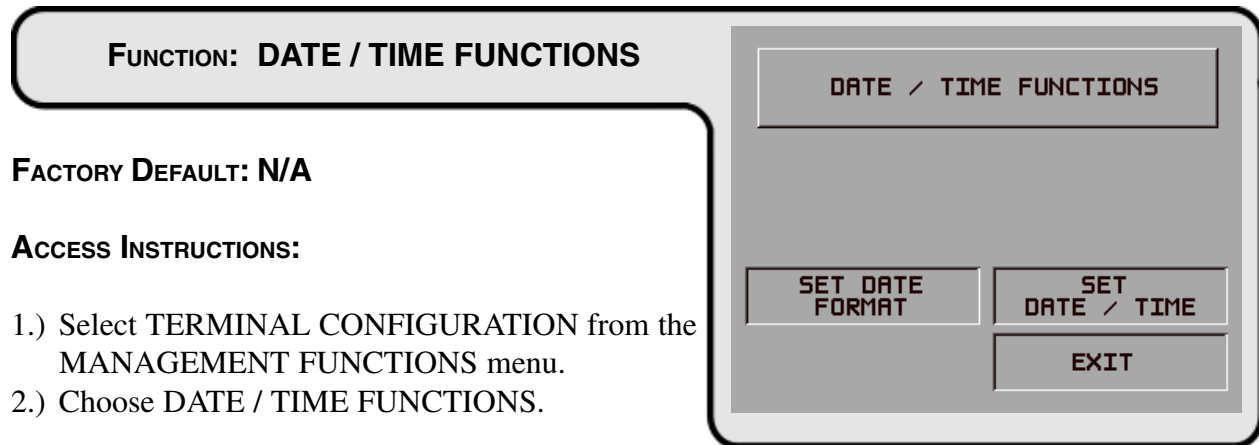
#### DESCRIPTION:

Selects the feature number to examine or to activate/deactivate. For example, entering the numbers “00” selects the Triton Connect feature. The current status of the feature will be displayed. Use the ACTIVATE and DEACTIVATE functions as appropriate to change the status of the selected feature.

#### ERROR CONDITIONS:

There are no error conditions directly associated with this function.

## SECTION 5 - MANAGEMENT FUNCTIONS



**FACTORY DEFAULT: N/A**

**ACCESS INSTRUCTIONS:**

- 1.) Select **TERMINAL CONFIGURATION** from the **MANAGEMENT FUNCTIONS** menu.
- 2.) Choose **DATE / TIME FUNCTIONS**.

**DESCRIPTION:**

This screen provides a menu of functions related to configuration of date and time parameters for the Cash Dispenser:

- 1.) **SET DATE FORMAT.** This option allows you to choose between a DD/MM/YY and a MM/DD/YY date format the terminal will use when printing receipts and other reports.
- 2.) **SET DATE / TIME.** This option enables you to configure the actual date and time the terminal uses when printing receipts and other reports.

**ERROR CONDITIONS:**

There are no error conditions directly associated with this function.

Compliments of: [www.atndepot.com](http://www.atndepot.com)

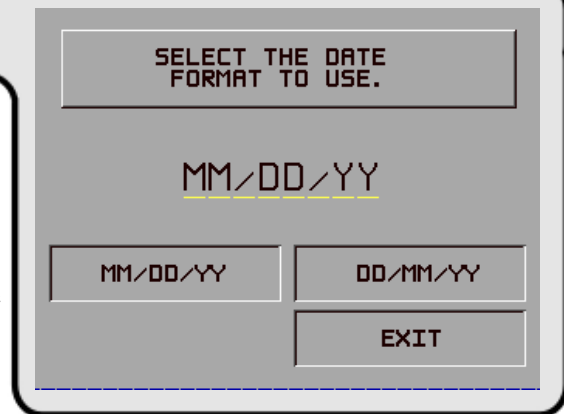
## SECTION 5 - MANAGEMENT FUNCTIONS

### FUNCTION: SET DATE FORMAT

**FACTORY DEFAULT:** MM/DD/YY

#### ACCESS INSTRUCTIONS:

- 1.) Select TERMINAL CONFIGURATION from the MANAGEMENT FUNCTIONS menu.
- 2.) Choose DATE / TIME FUNCTIONS.
- 3.) Choose SET DATE FORMAT.



#### DESCRIPTION:

This function provides a way to change the date format the terminal uses when printing a date field on receipts and reports. Press the button next to the desired option to activate that format.

#### ERROR CONDITIONS:

There are no error conditions directly associated with this function.

## SECTION 5 - MANAGEMENT FUNCTIONS

**FUNCTION: SET DATE / TIME**

**FACTORY DEFAULT: N/A**

**ACCESS INSTRUCTIONS:**

- 1.) Select **TERMINAL CONFIGURATION** from the **MANAGEMENT FUNCTIONS** menu.
- 2.) Choose **DATE/TIME FUNCTIONS**.
- 3.) Choose **SET DATE / TIME**

**DATE/TIME SET**

06/03/97	SET DATE-->
12:40:57 PM	SET TIME-->
EXIT- >	

**DESCRIPTION:**

The Cash Dispenser contains an internal clock that maintains the date and time, even when power is disconnected from the unit.

Press **SET DATE** to begin the date entry process. Press **SET TIME** to begin the time entry process.

**ERROR CONDITIONS:**

There are no error conditions directly associated with this function.

Compliments of: [www.atndepot.com](http://www.atndepot.com)

## SECTION 5 - MANAGEMENT FUNCTIONS

### FUNCTION: SET DATE

**FACTORY DEFAULT: N/A**

#### ACCESS INSTRUCTIONS:

- 1.) Select TERMINAL CONFIGURATION from the MANAGEMENT FUNCTIONS menu.
- 2.) Choose DATE/TIME FUNCTIONS.
- 3.) Select SET DATE / TIME.
- 4.) Select SET DATE..

#### \*SET DATE\*

MM/DD/YY

BACKSPACE-->

CLEAR-->

QUIT-->

SET DATE-->

#### DESCRIPTION:

Press SET DATE to begin the date entry process. The date is entered in the form 'MM/DD/YY' (month, day, year). Do not enter the '/' characters separating the fields, just the fields themselves. Press CLEAR to erase everything and start over. Press the BACKSPACE key to back up and erase a single character. Press QUIT to escape without doing anything. Press SET DATE to load the entered date into the clock.

The Cash Dispenser will not let you enter an invalid number for hours or minutes. The clock will properly handle the rollover to the year 2000.

#### ERROR CONDITIONS:

There are no error conditions directly associated with this function.



## SECTION 5 - MANAGEMENT FUNCTIONS

**FUNCTION: SET TIME**

**FACTORY DEFAULT: N/A**

**ACCESS INSTRUCTIONS:**

- 1.) Select **TERMINAL CONFIGURATION** from the **MANAGEMENT FUNCTIONS** menu.
- 2.) Choose **DATE/TIME FUNCTIONS**.
- 3.) Select **SET DATE / TIME**.
- 4.) Select **SET TIME...**

**DESCRIPTION:**

The time is entered in the form 'HH:MM:SS' (hours, minutes, seconds). Do not enter the ':' characters separating the fields, just the fields themselves. Press **CLEAR** to erase everything and start over. Press the **BACKSPACE** key to back up and erase a single character. Press **QUIT** to escape without doing anything. Press **SET TIME** to load the entered time into the clock.

The Cash Dispenser will not let you enter an invalid number for hours or minutes. The clock will properly handle the rollover to the year 2000.

**ERROR CONDITIONS:**

There are no error conditions directly associated with this function.

**\*SET TIME\***

PRESS 3 FOR AM OR 7 FOR PM

BACKSPACE-->

HH:MM:SS XM CLEAR-->

QUIT-->

SET TIME-->

Compliments of: [www.atndepot.com](http://www.atndepot.com)

## SECTION 5 - MANAGEMENT FUNCTIONS

**FUNCTION: TRANSACTION TYPES**

**FACTORY DEFAULT: ON**

**ACCESS INSTRUCTIONS:**

- 1.) Select the **TERMINAL CONFIGURATION** option from the **MANAGEMENT FUNCTIONS** screen.
- 2.) Select **TRANSACTION TYPES**.

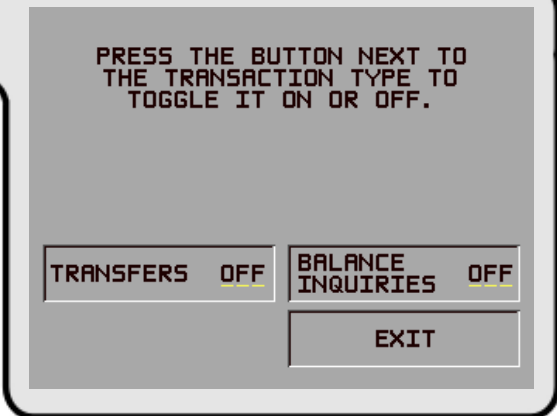
**DESCRIPTION:**

This function allows you to turn on or off the availability of the two transaction types: **TRANSFERS** and **BALANCE INQUIRIES**. When a transaction type is turned **ON**, the terminal will provide that option to the customer. When a transaction type is turned **OFF**, the selected transaction type will not be displayed to the customer.

The current state of the transaction type is shown as either **ON** or **OFF** in the applicable button label on the display. Press the button next to the label to toggle the state of the transaction type between **ON** and **OFF**.

**ERROR CONDITIONS:**

There are no error conditions directly associated with this function.



The screenshot shows a terminal screen with the title 'FUNCTION: TRANSACTION TYPES'. The screen displays three buttons: 'TRANSFERS OFF', 'BALANCE INQUIRIES OFF', and 'EXIT'. Above the buttons, the text reads: 'PRESS THE BUTTON NEXT TO THE TRANSACTION TYPE TO TOGGLE IT ON OR OFF.'

## SECTION 5 - MANAGEMENT FUNCTIONS

**FUNCTION: ACCOUNT TYPES**

**FACTORY DEFAULT: ON**

**ACCESS INSTRUCTIONS:**

- 1.) Select the **TERMINAL CONFIGURATION** option from the **MANAGEMENT FUNCTIONS** screen.
- 2.) Select **ACCOUNT TYPES**.

PRESS THE BUTTON NEXT TO THE ACCOUNT TYPE TO TOGGLE IT ON OR OFF.

SAVINGS    OFF	CREDIT CARD    ON
EXIT	

**DESCRIPTION:**

This function allows you to turn on or off the availability of two account types: SAVINGS and CREDIT CARD. When an account type is turned ON, the terminal will provide that option to the customer. When an account type is turned OFF, the selected account type will not be displayed to the customer.

The current state of the account type is shown as either ON or OFF in the applicable button label on the display. Press the button next to the label to toggle the state of the account type between ON and OFF.

**ERROR CONDITIONS:**

There are no error conditions directly associated with this function.

Compliments of: [www.atndepot.com](http://www.atndepot.com)

**For Sales & Service Call: 888-501-5246**

**Compliments of: [www.atmdepot.com](http://www.atmdepot.com)**

**SECTION 6**  
**MAINTENANCE**

**Compl i ments of: [www.atndepot.com](http://www.atndepot.com)**

## SECTION 6 - MAINTENANCE

---

### \*\*\* WARNING \*\*\*

**No attempt should be made to repair or service this unit by the user! Any such attempt may damage the unit and will void the warranty.**

### CLEANING THE ENCLOSURE

The Cash Dispenser front panel is highly durable, resisting scratches and finger smudges. However, occasional cleaning of the front panel and the plastic enclosure may be desirable. A soft dry or slightly damp cloth may be used for cleaning. For best results, a weak solution of a mild detergent and water should be used.

### \*\*\*WARNING\*\*\*

**Avoid using abrasive cleaners on any surface of the cash dispenser. Do not spray cleaner liquids directly on the unit. .**

### CLEANING THE DISPLAY

The Liquid Crystal Display (LCD) on the front of the cash dispenser has a plastic protective window that should be cleaned only with a SOFT cloth, dampened with a weak solution of a mild detergent and water.

### \*\*\*WARNING\*\*\*

**Do not use any abrasive cleaners on the window, as it will scratch. Do not spray liquids onto the screen, as they may run down inside the unit and cause damage.**

### CARD READER MAINTENANCE

Special cleaning cards are available for proper maintenance of the card reader. The reader should be cleaned at least once a month by inserting and removing a cleaning card, as shown in Figure 6-1. It may be necessary to clean the card reader more often in locations that see heavy usage.



*Figure 6-1. Use the cleaning cards on a monthly basis to maintain effective card reader operation.*

## SECTION 6 - MAINTENANCE

### REPLENISHING THE RECEIPT PAPER

**NOTE:**

**This operation can be completed with the AC Power applied to the Cash Dispenser**

1. This operation can be completed with the power on. Open the top of the cash dispenser by unlocking the top enclosure and pulling the hinged door forward.

**\*\*NOTE\*\***

The top enclosure access door is provided with a pneumatic piston to prevent the door from extending too far when opening and from being closed too quickly. In the unlikely event of the pneumatic piston not functioning properly, the door should be prevented from opening too far and from being slammed when closing.

2. Remove any paper that remains in the paper path as follows:
  - a. If paper remains on the roll, cut the paper between the roll and the printer with a pair of scissors as shown in Figure 6-2. Use the RECEIPT PRINTER PAPER FEED BUTTON (Figure 6-3) to feed the paper through the paper path until all paper comes out the front of the printer.

**NOTE:**

**Do not pull the paper backward through the printer. This may leave paper fragments that can cause paper jams.**

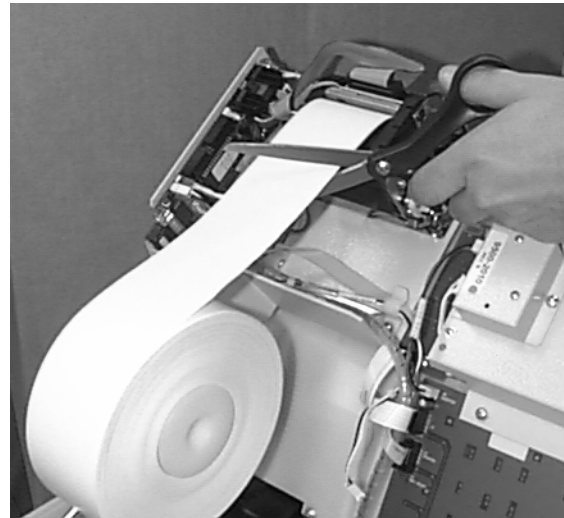


Figure 6-2. Cut any paper between the roll and the printer feed path with scissors.

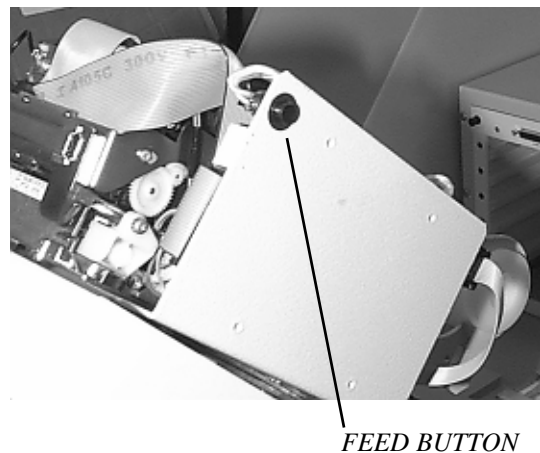


Figure 6-3. The PAPER FEED BUTTON.

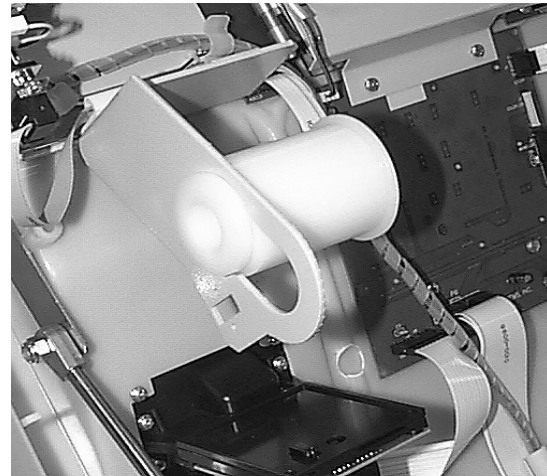
Compliments of: [www.atndepot.com](http://www.atndepot.com)

## SECTION 6 - MAINTENANCE

3. Push the paper spool (or partial roll of paper) from its location in Figure 6-4A to the position shown in Figure 6-4B.

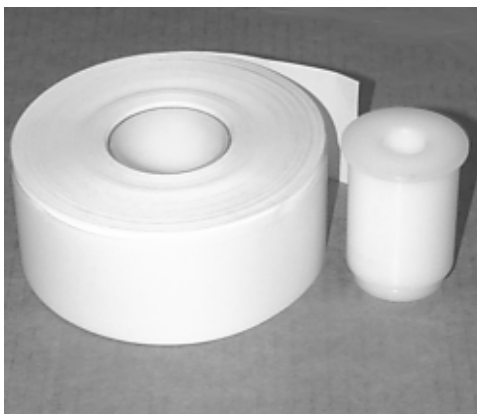


*Figure 6-4A. Paper Spool in its normal operating position.*



*Figure 6-4B The Paper Spool in position for removal.*

4. Remove the paper spool from the paper support bracket by pulling the slotted small end of the spool out of bracket.
5. Remove the tab securing the end of the new paper roll to itself. Use scissors to cut off all of the paper up to and including the glue tab. Insert the paper spool into the new roll of paper (as shown in Figures 6-5A and 6-5B). Use a 6-inch roll of 60-mm wide thermal paper. Be sure the paper spool is inserted so that the paper will feed **from the top of the roll** when it is installed on the paper bracket.



*Figure 6-5A. The paper and paper spool.*



*Figure 6-5B. Spool inserted into the roll of paper.*



## SECTION 6 - MAINTENANCE

- Place the paper roll and paper spool back on the paper bracket by sliding the small slotted end of the spool into the large hole in the bracket as shown in Figure 6-6A. Push the paper and spool into the operating position to lock them in place as seen in Figure 6-6B.



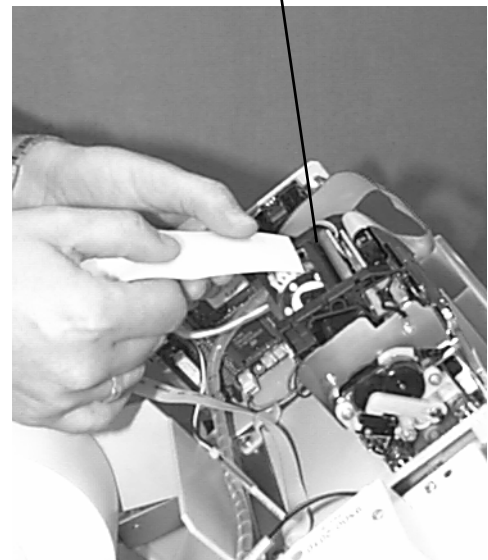
*Figure 6-6A. Placing the paper roll and spool on the paper bracket.*



*Figure 6-6B. Paper roll and spool in place for operation.*

- Once the paper roll and spool are installed on the paper bracket, take the end of paper roll and feed it into the printer path paper entrance, as shown in Figure 6-7.

*Insert end of paper here.*



*Figure 6-7. Feeding paper into the printer.*

Compliments of: [www.atndepot.com](http://www.atndepot.com)

## SECTION 6 - MAINTENANCE

---

8. Once the paper is fed into the paper path entrance, the printer will activate and automatically feed the paper through the printer and out the exit. See Figure 6-8.
9. Close and lock the Cash Dispenser.



*Figure 6-8. A new roll of paper installed on the Printer.*

Compliments of: [www.atndepot.com](http://www.atndepot.com)

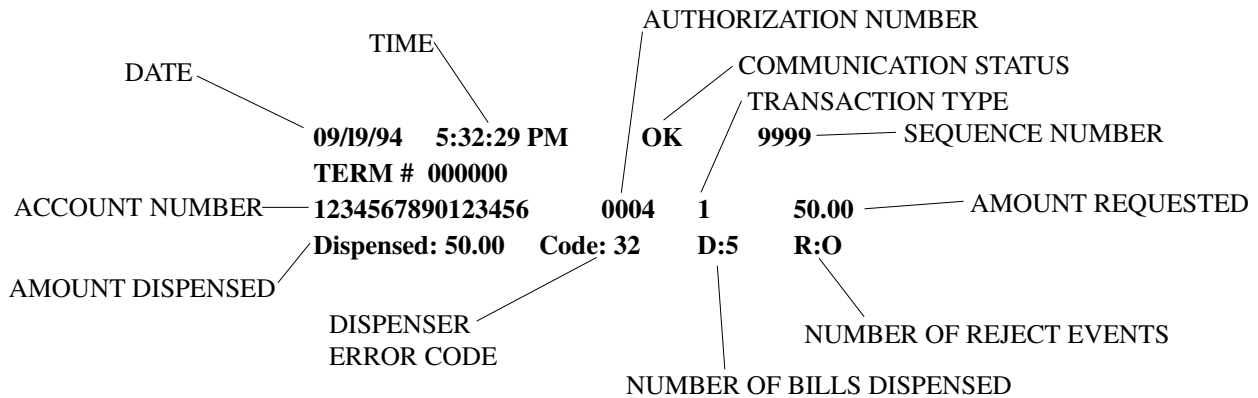
**SECTION 7**  
**JOURNAL ENTRIES**

**Compliments of: [www.atndepot.com](http://www.atndepot.com)**

## SECTION 7 - JOURNAL ENTRIES

### JOURNAL ENTRIES

Journal entries are printed on a per transaction basis. Each new entry begins with a blank line. The following is an example of a typical journal entry. In the case of a communications error, most of this information is omitted and an error code would be printed.



The transaction types are:

- 1 - Withdrawal from checking
- 2 - Withdrawal from savings
- 3 - Withdrawal from credit card
- 4 - Transfer checking to savings
- 5 - Transfer savings to checking
- 6 - Transfer credit to checking
- 7 - Transfer credit to savings
- 8 - Checking balance inquiry
- 9 - Savings balance inquiry
- 10 - Credit balance inquiry.

For an explanation of the dispenser error codes consult Section 8, Error Recovery. Each reject event will result in one or more bills in the reject compartment inside the note cassette.

**SECTION 8**  
**ERROR RECOVERY**

**Compl i ments of: [www.atndepot.com](http://www.atndepot.com)**

## SECTION 8 - ERROR RECOVERY

---

### INTRODUCTION

The Cash Dispenser operating system determines the operational status of each of its components by routinely performing a system status check. A status check is performed:

- 1.) During power up.
- 2.) Once every forty seconds while the dispenser is not in use.
- 3.) Before leaving the Management Functions main menu screen.
- 4.) After every transaction.

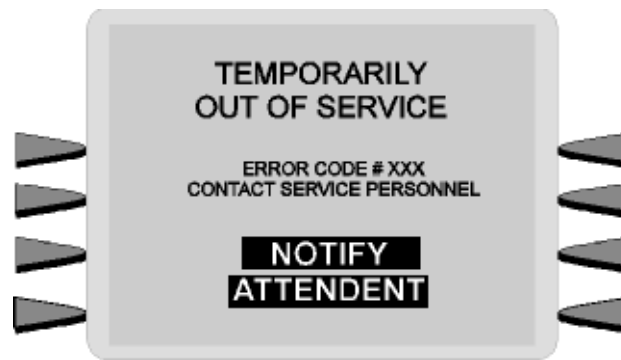


Figure 8-1. The “Out of Service” display.

An error detected during a status check will place the dispenser in an “OUT OF SERVICE” mode of operation and display the messages shown in Figure 8-1 on the LCD display screen.

### ERROR RECOVERY

Many error conditions require the assistance of a qualified service technician to return the Cash Dispenser to normal operation. But there are some actions that the end user can perform to confirm the existence of a problem or correct simple problems.

Table 8-1, Error Recovery Procedures, provides a list of error conditions that can cause the Cash Dispenser to enter an “OUT OF SERVICE” condition. The table lists the error codes, a description of each error message and possible corrective actions non-service personnel can perform in an attempt to return the unit to normal operation.

Many of the procedures direct you to RESET the Cash Dispenser as the first step. This action may be all that is necessary to clear the error indication. In other cases further actions may be necessary. If necessary, you will be directed to contact your service organization.

## SECTION 8 - ERROR RECOVERY

---



Figure 8-2. The location of the RESET and AC POWER Switch.

### RESETTING THE CASH DISPENSER

In the “OUT OF SERVICE” mode of operation the dispenser will not respond to any inputs to the keypad or card reader.



Figure 8-3. The RESET ERROR/MANAGEMENT Menu.

Try to return the dispenser to normal operation by performing a RESET. To do this, open the top enclosure access door (see CAUTION) and perform either of the following two actions:

- 1.) Press and then release the RESET Switch (See Figure 8-2).
- 2.) Turn the AC Power Switch OFF for a few seconds, then turn it back ON.

## SECTION 8 - ERROR RECOVERY

---

### **\*\*NOTE\*\***

The top enclosure access door is provided with a pneumatic piston to prevent the door from extending too far when opening and from being closed too quickly. In the unlikely event of the pneumatic piston not functioning properly, the door should be prevented from opening too far and from being slammed when closing.

After resetting the Cash Dispenser, the RESET ERROR/MANAGEMENT Menu (refer to Figure 8-3.) is displayed on the LCD display screen. This menu allows you to perform two actions:

- 1.) Enter MANAGEMENT mode.
- 2.) RESET the error that caused the OUT OF SERVICE condition.

After selecting the RESET ERROR option, and if no additional error conditions exist, the CUSTOMER WELCOME screen should appear. At this point one further step is usually recommended to confirm that the dispenser is working normally, and that is to perform a TEST DISPENSE. The success of this operation is usually a good indication that the overall dispenser control system and dispensing mechanism are working normally.

It is possible that more than one error condition exists. In these cases, after resetting the original error message (or after performing a TEST DISPENSE) a different error message may be displayed. Address each error message according to the instructions given in Table 8-1, until all problems have been corrected and the Cash Dispenser has been restored to normal operation, or you are instructed to contact your service organization.



## SECTION 8 - ERROR RECOVERY

TABLE 8-1 ERROR RECOVERY PROCEDURES		
Error/Status Code	Meaning	Recommended Actions
33	Feed Failure.	<p>Turn off the Cash Dispenser and open the security container. Inspect the dispensing mechanism feed path for jammed currency and currency sticking together. Clear the feed path as needed.</p> <p>Remove and inspect the cassette for damage that will prevent it from dispensing properly. Also, make sure the currency is fit for dispensing. If there is no currency in the cassette, see the IMPORTANT NOTE in the Recommended Actions for Error Code 182. If the suggested actions do not clear the feed failure indication, proceed with the remainder of this procedure.</p> <p>Verify that the packer plate is released. If there is no jammed currency, remove the first note from the cassette.</p> <p>Prime the cassette, install it in the dispenser mechanism and restore power to the Cash Dispenser.</p> <p>When the RESET ERROR/MANAGEMENT menu is displayed on the LCD, press the RESET ERROR key.</p> <p>If the error appears again, close and lock the security container. Call your service provider.</p> <p>If the error clears, enter the MANAGEMENT FUNCTIONS when the Top Menu is displayed. Enter your password.</p> <p>When the MANAGEMENT FUNCTIONS menu is displayed select DIAGNOSTICS.</p> <p>Press the PURGE key. The correct return code for a good purge is '20 20 20'. If any other return code is displayed, contact your service provider.</p> <p>Press the TEST DISPENSE key. The correct return code for a good test dispense is '20 20 21'. If any other return code is displayed contact your service provider.</p> <p>If the return codes are satisfactory, close and lock the security container.</p> <p>Place the Cash Dispenser back in service.</p>

Compliments of: [www.atndepot.com](http://www.atndepot.com)

## SECTION 8 - ERROR RECOVERY

TABLE 8-1 ERROR RECOVERY PROCEDURES		
Error/Status Code	Meaning	Recommended Actions
34	Mistracked note at feed.	See Recommended Actions for Error Code 33.
35	Mistracked note at double detect.	See Recommended Actions for Error Code 33.
36	Mistracked note at exit.	See Recommended Actions for Error Code 33.
37	Note too long for exit.	See Recommended Actions for Error Code 33.
38	Blocked exit.	See Recommended Actions for Error Code 33.
39	Too many notes.	<p>RESET the Cash Dispenser.</p> <p>If the error appears again, close and lock the security container. Call your service provider.</p> <p>If the error clears, enter the MANAGEMENT FUNCTIONS when the Top Menu is displayed. Enter your password.</p> <p>When the MANAGEMENT FUNCTIONS menu is displayed select DIAGNOSTICS.</p> <p>Press the PURGE key. The correct return code for a good purge is '20 20 20'. If any other return code is displayed, contact your service provider.</p> <p>Press the TEST DISPENSE key. The correct return code for a good test dispense is '20 20 21'. If any other return code is displayed contact your service provider.</p> <p>If the return codes are satisfactory, close and lock the security container.</p> <p>Place the Cash Dispenser back in service.</p>

Compliments of: [www.atndepot.com](http://www.atndepot.com)

## SECTION 8 - ERROR RECOVERY

TABLE 8-1 ERROR RECOVERY PROCEDURES		
Error/Status Code	Meaning	Recommended Actions
42	Timing wheel error.	See Recommended Actions for Error Code 39.
44	Bad roller profile.	See Recommended Actions for Error Code 39.
45	Diverter error.	See Recommended Actions for Error Code 39.
46	Exit quantified.	See Recommended Actions for Error Code 39.
47	Note missing at double detect.	See Recommended Actions for Error Code 39.
48	Reject rate exceeded.	<p>The most probable cause of this error is poor quality currency.</p> <p>Open the security container.</p> <p>Remove the cassette and inspect the currency to make sure it's fit for dispensing (refer to guidance in Section 4, Handling Cassettes). Replace currency as needed.</p> <p>Follow the Recommended Actions for Error Code 39.</p>
49	Jam at exit.	See Recommended Actions for Error Code 39.
50	Interference recovery.	See Recommended Actions for Error Code 39.
51	Suspect exit accountancy.	See Recommended Actions for Error Code 39.
52	RAM error.	See Recommended Actions for Error Code 39.
53	EPROM error.	See Recommended Actions for Error Code 39.

Compliments of: [www.atndepot.com](http://www.atndepot.com)

## SECTION 8 - ERROR RECOVERY

TABLE 8-1 ERROR RECOVERY PROCEDURES		
Error/Status Code	Meaning	Recommended Actions
54	Operation timeout.	See Recommended Actions for Error Code 39.
55	RAM corruption.	See Recommended Actions for Error Code 39.
56	Link Error	See Recommended Actions for Error Code 39.
128	Error in reply from the dispenser mechanism.	See Recommended Actions for Error Code 39.
129	No response from the dispenser mechanism.	See Recommended Actions for Error Code 39.
130	Command not acknowledged by the dispenser mechanism.	See Recommended Actions for Error Code 39.
131	CTS (Clear To Send) line from the dispenser mechanism is not active.	See Recommended Actions for Error Code 39.
132	Status reports bad double detect in last dispense.	See Recommended Actions for Error Code 39.
133	5 volts not present from dispenser mechanism.	See Recommended Actions for Error Code 39.
134	Exit blocked as reported by status check.	See Recommended Actions for Error Code 39.
135	Feed sensor blocked as reported by status check.	See Recommended Actions for Error Code 39.
136	Modem initialization failed.	<p>RESET the Cash Dispenser.</p> <p>If the error clears, put the Cash Dispenser back in service.</p> <p>If the error appears again, close and lock the security container. Call your service provider.</p>

Compliments of: [www.atndepot.com](http://www.atndepot.com)

## SECTION 8 - ERROR RECOVERY

TABLE 8-1 ERROR RECOVERY PROCEDURES		
Error/Status Code	Meaning	Recommended Actions
137	Print failure while printing to the journal printer.	This error code is applicable to Cash Dispensers equipped with a mechanical journal printer. It is not applicable to a standard unit equipped with an Electronic Journal.
138	Print failure while printing to the receipt printer.	<p>Open the top enclosure of the Cash Dispenser. Carefully clear the paper path with a business card or some similar object.</p> <p>With the aid of the paper feed switch feed cleanly cut paper through the printer and cutter mechanisms.</p> <p>Press the RESET switch.</p> <p>When the RESET ERROR/MANAGEMENT menu is displayed on the LCD, press the RESET ERROR key.</p> <p>If the error appears again, close and lock the security container. Call your service provider.</p>
139	Print controller not responding to commands.	See Recommended Actions for Error Code 136.
140	Timeout waiting for printer to be ready.	See Recommended Actions for Error Code 136.
141	Paper jam reported by controller during a status check.	See Recommended Actions for Error Code 138.

Compliments of: [www.atndepot.com](http://www.atndepot.com)

## SECTION 8 - ERROR RECOVERY

TABLE 8-1 ERROR RECOVERY PROCEDURES		
Error/Status Code	Meaning	Recommended Actions
142	Dispensing mechanism returns bad command error.	See Recommended Actions for Error Code 136.
143	PTDF error.	See Recommended Actions for Error Code 136.
144	No reply from the security module or electronic journal.	See Recommended Actions for Error Code 136.
145	Error in reply from security module or electronic journal.	See Recommended Actions for Error Code 136.
146	No reply from command to electronic journal.	See Recommended Actions for Error Code 136.
147	Error in reply from electronic journal.	See Recommended Actions for Error Code 136.
148	Write to electronic journal failed.	See Recommended Actions for Error Code 136.
149	Read from electronic journal failed.	See Recommended Actions for Error Code 136.
150	Status command to electronic journal failed.	See Recommended Actions for Error Code 136.
151	Electronic journal full.	<p>RESET the Cash Dispenser.</p> <p>When the RESET ERROR/MANAGEMENT menu is displayed on the LCD, press the MANAGEMENT key.</p> <p>Enter your password. When the MANAGEMENT FUNCTIONS menu is displayed press the JOURNAL key.</p> <p>When the SELECT JOURNAL FUNCTIONS menu is displayed press the PRINT JOURNAL key.</p> <p style="text-align: right;">Continued on next page...</p>

Compliments of: [www.atndepot.com](http://www.atndepot.com)

## SECTION 8 - ERROR RECOVERY

TABLE 8-1 ERROR RECOVERY PROCEDURES		
Error/Status Code	Meaning	Recommended Actions
151	Electronic journal full.	Continued from previous page...  After the PRINT JOURNAL function is finished, press the EXIT key until the RESET ERROR/MANAGEMENT menu is displayed.  Press the RESET ERROR key.  If the error clears, put the Cash Dispenser back in service.  If the error appears again, close and lock the security container. Call your service provider.
152	Electronic journal corrupt.	See Recommended Actions for Error Code 136.
153	Electronic journal mode.	See Recommended Actions for Error Code 136.
154	Unknown electronic journal status.	See Recommended Actions for Error Code 136.
155	Electronic journal modify record failure.	See Recommended Actions for Error Code 136.
157	Erase command to electronic journal failed.	See Recommended Actions for Error Code 136.
158	Format command to electronic journal failed.	See Recommended Actions for Error Code 136.
162	Electronic journal get serial number failed.	See Recommended Actions for Error Code 136.
163	Terminal did not answer.	See Recommended Actions for Error Code 136.
164	Terminal did not return call.	See Recommended Actions for Error Code 136.

Compliments of: [www.atndepot.com](http://www.atndepot.com)

## SECTION 8 - ERROR RECOVERY

TABLE 8-1 ERROR RECOVERY PROCEDURES		
Error/Status Code	Meaning	Recommended Actions
165	Electronic journal not present.	See Recommended Actions for Error Code 136.
166	Bad dispense.	See Recommended Actions for Error Code 136.
182	Currency cassette low.	<p>Open the security cabinet.</p> <p>Remove the cassette.</p> <p>Add currency to the cassette as needed.</p> <p>Place the cassette in the dispenser mechanism and close the security enclosure.</p> <p>Follow the Recommended Actions for Error Code 136.</p> <p><b>IMPORTANT NOTE:</b></p> <p>If the terminal dispenses all of its cash and the cassette has not been refilled with enough cash to position the packer plate far enough from the dispenser mechanism's Low Currency reed switch, the terminal will go into the Error 182 condition when the RESET ERROR key is pressed. To prevent this from occurring, follow these steps:</p> <ol style="list-style-type: none"> <li>1.) Remove the cassette from the dispenser mechanism.</li> <li>2.) Press the RESET ERROR key on the terminal.</li> <li>3.) Refill the cassette as necessary and install it in the dispenser mechanism.</li> </ol>
183	Receipt printer paper low.	Add paper as needed. If this does not correct the problem, you may wish to temporarily disable detection of this condition by setting the LOW RECEIPT PAPER parameter to IN SERVICE (see Section 5) to allow operation until the problem can be corrected by your service provider.
184	Journal printer paper low.	This error code is applicable to Cash Dispensers equipped with a mechanical journal printer. It is not applicable to a standard unit equipped with an Electronic Journal.



## SECTION 8 - ERROR RECOVERY

TABLE 8-1 ERROR RECOVERY PROCEDURES		
Error/Status Code	Meaning	Recommended Actions
185	Phone number not configured.	Refer to Section 3, Operation and Setup, and Section 5, Management Functions, for procedures for checking and setting this parameter.
186	Bill size not configured correctly.	Refer to Section 3, Operation and Setup, and Section 5, Management Functions, for procedures for checking and setting this parameter.
187	Maximum withdrawal not configured.	Refer to Section 3, Operation and Setup, and Section 5, Management Functions, for procedures for checking and setting this parameter.
188	Communications key not configured.	Refer to Section 3, Operation and Setup, and Section 5, Management Functions, for procedures for checking and setting this parameter.
189	Terminal ID not configured.	Refer to Section 3, Operation and Setup, and Section 5, Management Functions, for procedures for checking and setting this parameter.
190	Master Key not configured.	Refer to Section 3, Operation and Setup, and Section 5, Management Functions, for procedures for checking and setting this parameter.
192	Communication error.	Call your service organization.
195	Receipt paper out.	Call your service organization.
196	Card Reader Failure.	Call your service organization.
203	SPED keypad is not replying to main board.	Call your service organization.
205	The SPED keypad reported a tamper condition.	Call your service organization.
206	SPED could not perform a successful command within SPED_MAX_ATTEMPTS tries.	Call your service organization.
207	SPED Not Detected.	Call your service organization.

Compliments of: [www.atndepot.com](http://www.atndepot.com)

## SECTION 8 - ERROR RECOVERY

### MISCELLANEOUS ERROR CODES

The following tables lists miscellaneous error codes not included in the Terminal and Dispenser error code listings. It is recommended that troubleshooting of these error conditions be coordinated through your service provider.

MISCELLANEOUS ERROR CODES		
Error/Status Code	Meaning	Recommended Actions
1	Timeout	Contact your service provider for assistance.
3	BGD_NOANSWER	Contact your service provider for assistance.
4	Error in modem data	Contact your service provider for assistance.
6	BGD_NODIALTONE	Contact your service provider for assistance.
7	BGD_BUSY	Contact your service provider for assistance.
10	BGD_LOGON	Contact your service provider for assistance.
11	No connect	Contact your service provider for assistance.
13	BGD_DONE_GOOD	Contact your service provider for assistance.
14	EOT received	Contact your service provider for assistance.
15	Timed out waiting for EOT	Contact your service provider for assistance.
16	Communication problems	Contact your service provider for assistance.
65	Processor not communicating with modem correctly.	Contact your service provider for assistance.

**APPENDIX A**  
**MECHANICAL COMBINATION LOCK**  
**INSTRUCTIONS**

**Compliments of: [www.atndepot.com](http://www.atndepot.com)**

**For Sales & Service Call: 888-501-5246**

## APPENDIX A - MECHANICAL COMBINATION LOCK INSTRUCTIONS

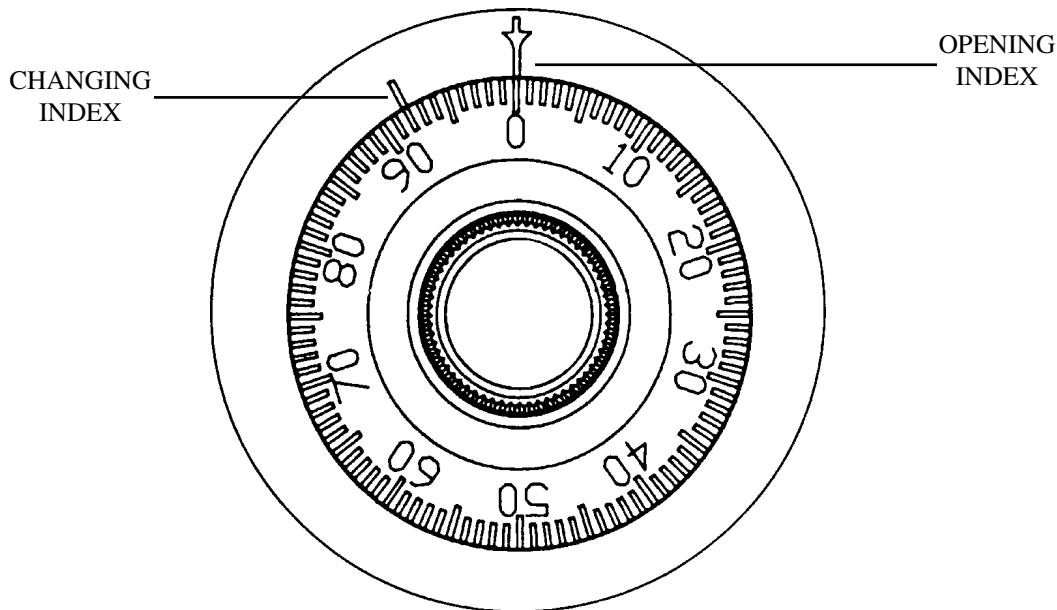
### ABOUT THE DIAL

There are two marks on the dial ring (see drawing). The index at the top is used for opening the lock, The index 30 degrees to the left is used only when changing the combination.

The dial should always be turned slowly and evenly. A revolution is counted each time the selected number is aligned with the opening index. **DO NOT TURN THE DIAL BACK TO COMPENSATE FOR OVER DIALING A NUMBER.** If, when dialing the combination, any number is turned beyond the index, the entire sequence must be repeated.

Locks are shipped on a factory setting of '50'. To unlock, turn the dial to the left (counterclockwise) **FOUR** turns stopping on '50'.

Then, turn the dial to the right until the bolt is retracted.



### UNLOCKING 3-NUMBER COMBINATIONS (FOR EXAMPLE, "50-25-50")

1. Turn the dial to the **LEFT**, stopping when '50' is aligned with the opening index, the **FOURTH** time.
2. Turn the dial to the **RIGHT**, stopping when '25' is aligned with the opening index, the **THIRD** time.
3. Turn the dial to the **LEFT**, stopping when '50' is aligned with the opening index, the **SECOND** time.
4. Turn the dial slowly to the **RIGHT** until the bolt retracts.

### To Lock

Turn the dial to the **LEFT** at least four full revolutions.

## APPENDIX A - MECHANICAL COMBINATION LOCK INSTRUCTIONS

---

### CHANGING THE COMBINATION

Select three new numbers. **DO NOT** use any number between 1 and 20 for the last number.

For maximum security, do not use numbers that end in 0 or 5, and do not use numbers in sequence: e.g., '27-48-86' is not as good as '27-86-48". Perform the following steps:

1. Dial the existing combination on the opening index (see steps 1-2-3 above, or the directions for opening when on the factory setting). Open door of container.
2. Dial the existing combination again, using the changing index.
3. With the last number set at the changing index, hold the dial securely and insert the change key in the keyhole in the back of the lock. Make sure the wing is entirely inside the lock and comes to a positive stop (see Figure 1) before turning the key.

\*\*\*WARNING\*\*\*

**NEVER INSERT THE CHANGE KEY IN THE LOCK WHEN THE COVER IS REMOVED. BEFORE TURNING THE CHANGE KEY, MAKE SURE THE WING OF THE KEY IS FULLY INSERTED INTO THE LOCK.**

4. Turn key one-quarter turn to the **LEFT** (see Figure 1). With the change key in this position, set the new combination as follows: turn the dial to the **LEFT**, stopping when the first number of the new combination aligns with the changing index the **FOURTH** time.

FIGURE 1

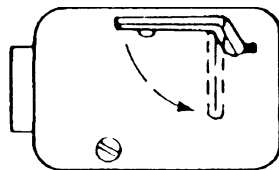
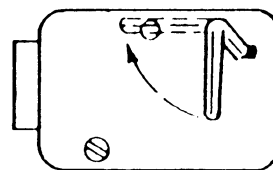


FIGURE 2



5. Turn dial to the **RIGHT**, stopping when the second number is aligned with the changing index, the **THIRD** time.
6. Turn the dial to the **LEFT**, stopping when the third number is aligned with the changing index, the **SECOND** time. Holding the dial in this position, turn the change key back to the **RIGHT** and remove it. (See Figure 2.) The new combination you have chosen is now set in the lock,

\*\*\*CAUTION\*\*\*

**BEFORE CLOSING THE UNIT  
TRY THE NEW COMBINATION SEVERAL TIMES  
USING THE OPENING INDEX.**

Compliments of: [www.atndepot.com](http://www.atndepot.com)

**For Sales & Service Call: 888-501-5246**

**Compliments of: [www.atmdepot.com](http://www.atmdepot.com)**

**APPENDIX B**  
**ELECTRONIC COMBINATION LOCK**  
**INSTRUCTIONS**

**Compliments of: [www.atndepot.com](http://www.atndepot.com)**

## APPENDIX B - ELECTRONIC COMBINATION LOCK INSTRUCTIONS

---

### ENTERING THE COMBINATION

The electronic lock combination consists of six digits. Upon arrival, the combination of the lock should already be set at 1-2-3-4-5-6. After installation on the safe has been completed, enter the preset combination and check for proper operation. After each keypress, the lock will beep. After the final digit has been entered, the lock will beep twice, and the open period will begin. When a valid combination has been entered, the operator will have approximately 3 seconds to open the lock. To open the lock, turn the dial clockwise. After the lock is opened, the door latch may be turned and the safe opened.

### CHANGING THE COMBINATION

To change the combination of the lock, simply follow these directions.

- Enter six zeros.
- Enter the current combination. (Initially set at 1-2-3-4-5-6)
- Enter the new combination twice.
- The combination is now changed. Enter the new combination to open the lock.

### LOCKOUT FEATURE

The electronic lock includes a WRONG TRY PENALTY lockout feature that prevents entry from unauthorized personnel. This feature performs as follows and CANNOT be disabled:

- Entry of four consecutive invalid combinations will disable the lock for 5 minutes. During this period, the panel LED will flash every 10 seconds. During this time the lock will remain closed and no other combination entries will be allowed.
- At the end of the lockout period, if two more consecutive invalid combinations are entered, the 5-minute lockout period will restart.

### BATTERY REPLACEMENT

Repeated beeping while the lock is open indicates that the 9 volt battery, located in the battery box on the inside of the door, needs to be replaced. To remove the battery box cover, pull gently on the front of the box and slide the cover off. If the lock will not operate while the door is closed and locked, (i.e. no signal from the panel when a button is pressed), the battery is dead and the lock will need to be energized from the two round jumper terminals located on the front, right side of the push-button panel. To energize the lock, connect a 9-volt battery across the external terminals with the negative terminal of the battery facing up. While holding the battery against the terminals, enter the six-digit combination and open the lock and door. Replace the battery inside the battery box.



**APPENDIX C**  
**WARRANTY AND REPAIR**  
**POLICIES/PROCEDURES**

**Compl i ments of: [www. atndepot. com](http://www.atndepot.com)**

## APPENDIX C - WARRANTY AND REPAIR POLICIES/PROCEDURES

---

### Notices

Copyright ©1998 - Triton Systems, Inc.; 21405 B Street.; Long Beach, MS 39560 USA

### All Rights Reserved

This publication is protected by copyright and all rights are reserved. No part of it may be reproduced or transmitted by any means or in any form, without prior consent in writing from Triton Systems, Inc.

The information in this publication has been carefully checked and is believed to be accurate. However, Triton Systems, Inc. assumes no responsibility for any inaccuracies, errors, or omissions that may be contained in this document. In no event will Triton Systems, Inc. be liable for direct, indirect, special, incidental, or consequential damages resulting from any defect or omission in this manual, even if advised of the possibility of such damages.

In the interest of continued product development, Triton Systems, Inc. reserves the right to make improvements in its documentation and the products it describes at any time, without notice or obligation.

### Trademark Acknowledgments

*miniATM*<sup>™</sup> is a trademark of Triton Systems, Inc.

**APPENDIX C - WARRANTY AND REPAIR POLICIES/PROCEDURES**

---

**TRITON SYSTEMS, Inc.**

**Warranty Statement**

**Parts Only Limited Manufacturer’s Warranty**

Triton Systems, Inc. warrants the components of each Model 9600 Series Cash Dispenser, MAKO™ Cash Dispenser and SuperScrip™ Scrip Terminal, excluding software and related documentation, against any defect in materials and/or workmanship for a period of 13 months from the shipping date. The additional 30 days are intended to allow for the elapsed time between the shipment of the unit and its installation. If a component fails due to defects in materials and/or workmanship within the warranty period, Triton will furnish a new or refurbished component, at its discretion. Triton shall not be responsible for labor or other costs associated with installing the component; and the failed component shall be returned to Triton at the purchaser’s expense. Triton shall not be responsible for misuse or abuse of a unit; and any attempts to remove or deface the serial number or date code on a unit or any component thereof, or any attempt to repair a unit or to repair or replace any component by anyone other than a service technician authorized by Triton shall void this warranty.

**Limited Warranty covers normal use. Triton Systems does not warrant or cover damage:**

- occurring during shipment of the equipment or components from or to Triton’s facilities;
- caused by accident, impact with other objects, dropping, falls, spilled liquids, or immersion in liquids;
- caused by a disaster such as fire, flood, wind, earthquake, lightning, or other acts of God;
- caused by failure to provide a suitable installation environment for the equipment, including but not limited to, faulty wiring in the building in which the equipment is installed, installation in a facility with uncontrolled environmental conditions, failure to provide a dedicated electrical circuit on which the equipment operates, and/or lack of proper earth grounding for the equipment;
- caused by the use of the equipment for purposes other than those for which it was designed;
- resulting from improper maintenance;
- caused by any other abuse, misuse, mishandling, or misapplication.

Under no circumstances shall Triton Systems or its suppliers be liable for any special, incidental, or consequential damages based upon breach of warranty, breach of contract, negligence, strict liability, or any other legal theory. Such damages include, but are not limited to, loss of profits, loss of revenue, loss of data, loss of use of the equipment or any associated equipment, cost of capital, cost of substitute or replacement equipment, facilities or services, down time, purchaser’s time, the claims of third parties, including customers, and injury to property.

**Disclaimer of Warranties**

The warranty stated above is the only warranty applicable to this product. All other warranties, expressed or implied (including all implied warranties of merchantability or fitness for a particular purpose or quality of service), are hereby disclaimed. No oral or written information, or advice given by Triton Systems, its agents or employees shall create a warranty or in any way increase the scope of this warranty.

**Compliments of: [www.atmdepot.com](http://www.atmdepot.com)**

## APPENDIX C - WARRANTY AND REPAIR POLICIES/PROCEDURES

---

### Other Claims

#### Shipping Damage

All equipment is shipped FOB, Triton's facilities. The organization or individual who has purchased the equipment assumes responsibility for the equipment once it leaves Triton's facilities.

Should your equipment be damaged in the process of shipment or delivery to your place of destination, we recommend the following course of action:

- If possible, call the shipping company before the driver leaves your delivery site. Make note of the damage on the "receipt of delivery" paperwork. If this is not possible, call them as soon as possible to report the damage.
- Take photographs of the damaged packaging prior to opening the boxes. If this is not possible, make note of key points, such as whether the equipment is on a pallet, if the banding is intact, how the boxes are damaged, etc. Keep all of the packaging for inspection by the shipping company.
- If you unpack the equipment, take photographs of the damaged equipment. If this is not possible, make note of the damages.
- You must file a claim with the shipper for shipping damages immediately after reporting the damages.

Should you specify the carrier, we recommend that you explore with this chosen carrier the policies and procedures regarding shipping damage claims prior to selecting them as your preferred carrier.

If the equipment receives structural damage and is in an un-installable condition, Triton will work with you to arrange for a replacement unit to be shipped as soon as possible. The purchaser will be billed for the replacement unit. Triton's Repair Technicians will repair the damaged unit after it is returned to our facilities. We will credit the purchaser's account for the full purchase price of the damaged unit, minus the cost of returning the unit to "like new" condition. Under no circumstances does Triton authorize anyone to complete structural damage repairs in the field. Therefore, we will not ship primary structural parts, such as a cabinet head or main cabinet body for repair in the field.

#### Authorized Installation and Service Providers

Triton Systems utilizes several nation-wide and regional authorized third party maintenance providers. All miniATM™ Cash Dispensers must be installed and serviced by service technicians certified by Triton. This includes authorized third party service technicians and technicians who have been factory trained by Triton to service *miniATM™* equipment. Installation or repairs attempted by unauthorized service technicians automatically voids the warranty on the product.

Please contact Triton Systems' Technical Services Department at (800) 259-6672 for a list of our third party service providers and/or to obtain information on the requirements and procedures for becoming a certified Triton service technician.

---

## APPENDIX C - WARRANTY AND REPAIR POLICIES/PROCEDURES

---

### Triton's Technical Services Department

The primary purpose of the Technical Services Department is to provide assistance to customers in the operation, trouble shooting, and repair of equipment manufactured by Triton. A toll-free phone number (1-800-259-6672) is provided for convenience. The Technical Services Department operates to serve our customers. The staff is trained to follow our policies and procedures to ensure fair and uniform treatment of all our customers.

**Automated Voice Mail System.** Our goal is to have a 'live' person answer 100% of all incoming calls (during regular support hours). On occasion, however, call loads may exceed the capacity of the staff. When this occurs, an automated voice mail system will answer the call, indicate to the caller that all Technical Support Specialists are busy assisting others, and ask the caller to leave detailed information about the nature of the call.

Should it become necessary to leave a voice mail message, the caller should state:

- their name
- the organization for which they work
- the serial number of the equipment they are calling about
- detailed description of the problem that they are experiencing
- phone number where they can be reached, including area code.

As Technical Support Specialists become available, they check for voice mail messages and return calls in the order in which they were received. By providing the information requested in the voice mail, the technician can be prepared when your call is returned. Triton asks you to be patient if you must leave voice mail, and assures you that your call is important to us and that we will respond promptly.

**Calls for Service or Repair.** Calls for service or repair will be accepted from authorized service technicians only. End users must contact either the sales organization that placed the equipment or an authorized third party service organization to obtain service. The sections that follow describe the policies and procedures that relate to the repair and replacement of malfunctioning equipment.

**Questions on Operation of Equipment.** Technical support is available to owners of Triton equipment and to qualified service personnel. When calling for help with the configuration or operation of a Triton product, the caller must provide either positive identification as a service technician or the serial number of a Triton terminal. Technical support is provided during normal business hours for the life of the product.

When calling for help with an operational Problem, please have available information pertaining to the nature of the trouble. This includes the type of equipment, examples of what is or is not happening, and the name of the processor that supports your terminal.

All questions pertaining to the settlement of accounts, transaction inquiries, and fund status must be directed to the processor. Triton does not have access to the information needed to answer questions relating to specific transactions.

## APPENDIX C - WARRANTY AND REPAIR POLICIES/PROCEDURES

---

### CONTACT INFORMATION

TRITON SYSTEMS, IN21405 B STREET  
21405 B STREET  
LONG BEACH, MS 39560

#### Sales:

(800) 367-7191  
(228) 868-1317  
(228) 868-0437 FAX

#### Service:

(800) 259-6672  
(228) 868-0859 FAX

Compliments of: [www.atndepot.com](http://www.atndepot.com)

# INDEX

Compliments of: [www.atndepot.com](http://www.atndepot.com)

# INDEX

---

## A

Access Instructions 5-3  
 ALPHANUMERIC KEYS 3-3  
 Americans with Disabilities Act 3-3  
 Audit Trail 5-30  
 Audited Records 5-31

## B

BLUE Key 3-3  
 Braille 3-3  
 Buffer Memory 5-32

## C

Card Reader, Cleaning 6-2  
 Cleaning  
   Cash Dispenser Enclosure 6-2  
   LCD Display 6-2  
 Configuration, Initial  
   MAC Master/Working Keys 3-8  
   Multiple Amount 3-7  
   PIN Master/Working Keys 3-8  
   Surcharge Mode 3-7  
   Telephone Number 3-7  
   Terminal Number 3-6  
 CPU Module 5-23  
 Customer Transactions 3-2  
 Customer Welcome Screen 3-2

## D

DATAPAK 3000 1-2  
 Day Close Time 5-8  
 Default Value 5-3  
 Dispensed Note Count 5-9, 5-13, 5-20  
 Display, LCD  
   256-Color 1-2  
   Monochrome 1-2

## E

Electronic Journal 5-7  
 EPROM  
   Upgrade Requirement 1-2  
 Error Conditions 5-3  
 Error Recovery 8-2

## F

Features, General 2-2

## Features, New

DATAPAK 3000 1-2  
 Improved Monochrome Support 1-2  
 MACing 1-2  
 SPED 1-2

## Features, Standard

AD Screens 2-9  
 Alarm Thresholds 2-6  
 Close Scheduling 2-5  
 Color Display Option 2-11  
 Date/Time Format 2-12  
 Dispense Counter 2-12  
 Distributor EPROM Access With Challenge 2-7  
 Electronic Journal 2-6  
 Exit Message 2-6  
 Extended Amounts 2-12  
 International Monetary Support 2-8  
 Language Option 2-7  
 LED Sign Option 2-12  
 Memory Expansion Modules 2-8  
 Predial Capability 2-6  
 Prize Coupons Option 2-10  
 Quad-Port Module 2-8  
 Receipt Option 2-11  
 Receipt Printer Graphics 2-10  
 Receipt Printer Paper Low Option 2-8  
 Six-Digit Amount Entry Fields 2-8  
 Status Monitoring 2-7  
 Text-Based AD Screens 2-10  
 Transaction and Account Type Configuration 2-6  
 Triton Connect 2-11

## I

ISO 5-63

## J

Journal Transaction Types 7-2

## K

KEY MANAGEMENT 5-73  
 Keypad 3-3  
 Keypad Operation 3-3

## L

LCD Display 3-3



# INDEX

---

## M

MAC 1-2  
 Management Functions  
   Accessing 3-5, 5-2  
 Management Functions Chart 5-4  
 Media Condition 4-2  
   New or Uncirculated Currency 4-2  
   Used Currency 4-2  
 Memory Expansion Card 5-112  
 Memory Expansion Cards 5-19  
   Formatting 5-19  
 Menu  
   Operation 3-2  
   Top 3-2  
 Modem 5-23

## P

Paper Jams 5-38  
 Parameters, Additional Setup 3-8  
   Coupon Options 3-10  
   Date/Time Format 3-10  
   Language Option 3-10  
   Marketing Message 3-9  
   Maximum Amount 3-8  
   Receipt Option 3-10  
   Store Message 3-9  
   Surcharge Owner 3-9  
   Terminal Owner 3-9  
   Welcome Message 3-9  
 Parameters Listing 3-10  
 Processor 1-3

## R

Receipt Paper, Replenishing 6-3  
 Receipts, Management Function 5-9  
   Cassette Close 5-14  
   Day Close 5-11  
   Receipt Printer 5-20  
   Trial Cassette Close 5-9  
   Trial Day Close 5-10  
 Replenishing Currency 4-2  
 Resetting the Cash Dispenser 8-3  
 Return Code  
   Purge 5-17  
   Receipt Printer Test 5-20  
   Status 5-16  
   Test Dispense 5-18

## S

Schedule  
   Close 5-7  
   Journal 5-118  
 Screen Keys 3-3, 3-5  
 Service, Types of  
   Business Hours Service 1-3  
   Level 1, 24-Hour Service 1-3  
 Settlement \$ 5-10  
 SPED 1-2

## T

Text, Entering via Keypad 3-3  
 Timeout 3-2  
 Top Menu 3-2, 3-5, 3-6  
 Track 1/2 5-24

## W

Winning Percentage 5-46